



MOBILITY REIMAGINED

Investor Presentation
April 2022

Disclaimer

Confidentiality and Disclosures

This presentation has been prepared for use by EVE UAM, LLC ("Eve" or the "Company") and Zanite Acquisition Corp. ("Zanite") in connection with their proposed business combination (the "Transaction"). This presentation is for information purposes only and is being provided to you solely in your capacity as a potential investor in considering an investment in Zanite and may not be reproduced or redistributed, in whole or in part, without the prior written consent of Eve and Zanite. By accepting this presentation, each recipient and its directors, partners, officers, employees, attorney(s), agents and representatives ("recipient") agrees: (i) to maintain the confidentiality of all information that is contained in this presentation and not already in the public domain and (ii) to return or destroy all copies of this presentation or portions thereof in its possession following the request for the return or destruction of such copies. This presentation supersedes and supplements any prior presentation and any oral or written communication with respect to Eve and its business.

The Company and Zanite are free to conduct the process of the potential transaction as they deem in their sole discretion (including, without limitation, terminating further participation in the process by any party, negotiating with prospective transaction counterparties and entering into an agreement with respect to the Transaction without prior notice to you or any other person) and any procedures relating to such Transaction may be changed at any time without prior notice to you or any other person. None of Eve, Zanite or any other person undertakes any obligation to provide you with access to any additional information. This presentation shall not be deemed an indication of the state of affairs of Eve nor shall it constitute an indication that there has been no change in the business or affairs of Eve since the date hereof.

No Representations and Warranties

None of Eve, Zanite or any of their respective subsidiaries, stockholders, affiliates, representatives, partners, directors, officers, employees, investment banks, agents or advisers makes any express or implied representation or warranty as to the accuracy or completeness of the information contained in this presentation or any other written, oral or other communications transmitted or otherwise made available to any party in the course of its evaluation of a possible transaction between Eve and Zanite. To the fullest extent permitted by law, in no circumstances will the Company, Zanite or any of their respective subsidiaries, stockholders, affiliates, representatives, partners, directors, officers, employees, investment banks, agents or advisers be responsible or liable for any direct, indirect or consequential loss or loss of profit arising from the use of this Presentation, its contents, its omissions, reliance on the information contained within it, or on opinions communicated in relation thereto or otherwise arising in connection therewith.

You will be entitled to rely solely on the representations and warranties made to you by Zanite in a definitive written agreement relating to a Transaction, when and if executed, and subject to any limitations and restrictions as may be specified in such definitive agreement. No other representations and warranties will have any legal effect. The Company and Zanite expressly disclaim any and all liability for representations, expressed or implied, contained herein or for errors, omissions or misstatements, negligent or otherwise, in this presentation or any other written or oral communication transmitted to you in the course of your evaluation of a potential transaction.

The recipient agrees and acknowledges that this presentation is not intended to form the basis of any investment decision by the recipient and does not constitute investment, tax or legal advice regarding any securities. You should consult your own legal, regulatory, tax, business, financial and accounting advisors to the extent you deem necessary, and must make your own decisions and perform your own independent investment and analysis of an investment in Zanite and the transactions contemplated in this presentation. The recipient also acknowledges and agrees that the information contained in this presentation and any oral statements made in connection with this presentation are preliminary in nature, subject to material change and not intended to be all-inclusive or to contain all the information that a person may desire in considering an investment in Zanite. Zanite and Eve disclaim any duty to update the information contained in this presentation.

By participating in this Presentation, the recipient acknowledges that such recipient is aware that the United States securities laws restrict persons with material non-public information about a company obtained directly or indirectly from that company from purchasing or selling securities of such company, or from communicating such information to any other person, under circumstances in which it is reasonably foreseeable that such person is likely to purchase or sell such securities on the basis of such information.

No Offer or Solicitation

This presentation and any oral statements made in connection with this presentation shall neither constitute an offer to sell nor the solicitation of an offer to buy any securities, or the solicitation of any proxy, vote, consent, authorization or approval in any jurisdiction in connection with the proposed Transaction, nor shall there be any sale of securities in any jurisdiction in which the offer, solicitation or sale would be unlawful prior to the registration or qualification under the securities laws of any such jurisdictions. No such offering of securities shall be made except by means of a prospectus meeting the requirements of Section 10 of the Securities Act of 1933, as amended (the "Securities Act"). Investment in any securities described herein has not been approved or disapproved by the SEC or any other regulatory authority nor has any authority passed upon or endorsed the merits of the offering or the accuracy or adequacy of the information contained herein.

Any offering of securities (the "Securities") will not be registered under the Securities Act and will be offered as a private placement to a limited number of institutional "accredited investors" as defined in Rule 501(c)(1), (2), (3) or (7) under the Securities Act and "Institutional Accounts" as defined in FINRA Rule 4512(c). Accordingly, the Securities must continue to be held unless a subsequent disposition is exempt from the registration requirements of the Securities Act. Investors should consult with their counsel as to the applicable requirements for a purchaser to avail itself of any

exemption under the Securities Act. The transfer of the Securities may also be subject to conditions set forth in an agreement under which they are to be issued. Investors should be aware that they might be required to bear the financial risk of their investment for an indefinite period of time. Neither Zanite nor the Company is making an offer of the Securities in any state where the offer is not permitted.

This communication is restricted by law; it is not intended for distribution to, or use by any person in, any jurisdiction where such distribution or use would be contrary to local law or regulation.

Forward-Looking Statements

This presentation includes "forward-looking statements" within the meaning of the "safe harbor" provisions of the Private Securities Litigation Reform Act of 1996. Zanite's and Eve's actual results may differ from their expectations, estimates and projections and consequently, you should not rely on these forward-looking statements as predictions of future events. Words such as "expect", "estimate", "project", "budget", "forecast", "anticipate", "intend", "plan", "may", "will", "could", "should", "believes", "predicts", "potential", "continue", and similar expressions are intended to identify such forward-looking statements. These forward-looking statements include, without limitation, Zanite's and Eve's expectations with respect to future performance and anticipated financial impacts of the Transaction, the satisfaction of closing conditions to the Transaction and the timing of the completion of the Transaction. These forward-looking statements involve significant risks and uncertainties that could cause the actual results to differ materially from the expected results. You should carefully consider the risks and uncertainties described in the "Risk Factors" section of Zanite's registration statement on Form S-1 and annual report on Form 10-K/A and Embracer S.A.'s ("Embracer") annual report on Form 20-F. In addition, there will be risks and uncertainties described in the proxy statement relating to the proposed Transaction, a preliminary version of which has been filed by Zanite with the Securities and Exchange Commission (the "SEC") and other documents filed by Zanite from time to time with the SEC. These filings identify and address other important risks and uncertainties that could cause actual events and results to differ materially from those contained in the forward looking statements. Most of these factors are outside Zanite's and Eve's control and are difficult to predict. Factors that may cause such differences include, but are not limited to: (1) the outcome of any legal proceedings that may be instituted against Zanite or Eve following the announcement of the Transaction; (2) the inability to complete the proposed Transaction, including due to the inability to concurrently close the proposed Transaction and the private placement of common stock or due to failure to obtain approval of the securityholders of Zanite; (3) delays in obtaining, adverse conditions contained in, or the inability to obtain necessary regulatory approvals or complete regular reviews required to complete the Transaction; (4) the risk that the Transaction disrupts current plans and operations as a result of the announcement and consummation of the Transaction; (5) the inability to recognize the anticipated benefits of the Transaction, which may be affected by, among other things, competition, the ability of the combined company to grow and manage growth profitably, maintain relationships with customers and suppliers and retain its key employees; (6) costs related to the Transaction; (7) changes in the applicable laws or regulations; (8) the possibility that the combined company may be adversely affected by other economic, business, and/or competitive factors; (9) the impact of the global COVID-19 pandemic; and (10) other risks and uncertainties indicated from time to time described in Zanite's registration on Form S-1 and Embracer's annual report on Form 20-F, including those under "Risk Factors" therein, and in Zanite's and Embracer's other filings with the SEC. Zanite and Eve caution that the foregoing list of factors is not exclusive and not to place undue reliance upon any forward-looking statements, including projections, which speak only as of the date made. Neither Zanite nor Eve undertakes or accepts any obligation to release publicly any updates or revisions to any forward-looking statements to reflect any change in its expectations or any change in events, conditions or circumstances on which any such statement is based.

Use of Data

This presentation contains information concerning Eve's industry, including market size and growth rates of the markets in which Eve participates, that are based on industry surveys and publications or other publicly available information, other third-party survey data and research reports commissioned by Eve and its internal sources. This information involves many assumptions and limitations, there can be no guarantee as to the accuracy or reliability of such assumptions and you are cautioned not to give undue weight to this information. Further, no representation is made as to the reasonableness of the assumptions made within or the accuracy or completeness of any projections or modeling or any other information contained herein.

Any data on past performance or modeling contained herein is not an indication as to future performance. Neither Eve nor Zanite have independently verified this third-party information. Similarly, other third-party survey data and research reports commissioned by Eve or Zanite, while believed to be reliable, are based on limited sample sizes and have not been independently verified by Eve or Zanite. In addition, projections, assumptions, estimates, goals, targets, plans and trends of the future performance of the industry in which Eve operates, and its future performance, are necessarily subject to uncertainty and risk due to a variety of factors, including those described above. These and other factors could cause results to differ materially from those expressed in the estimates made by independent parties and by Eve and Zanite. Eve and Zanite assume no obligation to update the information in this presentation. Accordingly, this presentation is being delivered to you with the understanding that you will conduct your own independent investigation of those matters, which you deem appropriate without reliance on Zanite, Eve or any materials set out in this presentation.

All summaries and discussions of documentation and/or financial information contained herein are qualified in their entirety by reference to the actual documents and/or financial statements.

Disclaimer (cont.)

Projections

This Presentation contains financial forecasts for the Company with respect to certain financial results for the Company's fiscal years 2020 through 2030. All projections, estimates, goals, targets, plans, trends or other statements with respect to future results or future events in this presentation, including projected revenue, are forward-looking statements that (i) reflect various estimates and assumptions concerning future industry performance, general business, economic and regulatory conditions, market conditions for the Company's products and other matters, which assumptions may or may not prove to be correct, (ii) are inherently subject to significant contingencies and uncertainties, many of which are outside the control of Eve and Zanite and (iii) should not be regarded as a representation by Eve, Zanite or any other person that such estimates, forecasts or projections will be achieved. Neither Zanite's nor Eve's independent auditors have studied, reviewed, compiled or performed any procedures with respect to the projections for the purpose of their inclusion in this presentation, and accordingly, neither of them expressed an opinion or provided any other form of assurance with respect thereto for the purpose of this presentation. These projections are for illustrative purposes only and should not be relied upon as being necessarily indicative of future results. Actual results can be expected to vary and those variations may be material. Unanticipated events may occur that could affect the outcome of such projections, estimates, goals, targets, plans, trends and other statements. You must make your own determinations as to the reasonableness of these projections, estimates, goals, targets, plans, trends and other statements and should also note that if one or more estimates change, or one or more assumptions are not met, or one or more unexpected events occur, the performance and results set forth in such projections, estimates, goals, targets, plans, trends and other statements may not be achieved. We can give no assurance as to future operations, performance, results or events. The inclusion of financial projections, estimates and targets in this presentation should not be regarded as an indication that Eve and Zanite, or their representatives, considered or consider the financial projections, estimates and targets to be a reliable prediction of future events.

Use of Non-GAAP Financial Metrics

This presentation includes certain financial measures not presented in accordance with generally accepted accounting principles in the United States ("GAAP"), including EBITDA, EBITDA margin, free cash flow, non-GAAP gross profit and non-GAAP gross margin (including on a forward-looking basis) and certain other ratios and other metrics derived therefrom. The Company defines EBITDA as net income (loss) before depreciation and amortization, income taxes, interest income / expense and stock-based compensation, and EBITDA margin as EBITDA divided by revenue. The Company defines free cash flow as cash flow from operations minus capital expenditures. The Company defines non-GAAP gross profit as gross profit excluding depreciation and amortization and stock-based compensation expense included in cost of goods sold, and non-GAAP gross margin as non-GAAP gross profit divided by revenue. These financial measures are not measures of financial performance in accordance with GAAP and may exclude items that are significant in understanding and assessing our financial results. Therefore, these measures should not be considered in isolation or as an alternative to net loss or other measures of profitability, liquidity or performance under GAAP. You should be aware that our presentation of these measures may not be comparable to similarly titled measures used by other companies, which may be defined and calculated differently. Eve believes that these non-GAAP measures of financial results (including on a forward-looking basis) provide useful supplemental information to investors about Eve. Eve's management uses forward-looking non-GAAP measures to evaluate Eve's projected financials and operating performance. Other companies may calculate non-GAAP measures differently, or may use other measures to calculate their financial performance, and therefore the Company's non-GAAP measures may not be directly comparable to similarly titled measures of other companies. Management does not consider these non-GAAP measures in isolation or as an alternative to financial measures determined in accordance with GAAP. The principal limitation of these non-GAAP financial measures is that they exclude significant expenses and income that are required by GAAP to be recorded in the Company's financial statements. Given the inherent uncertainty regarding projections, projected non-GAAP measures have not been reconciled back to the nearest GAAP measure. In addition, they are subject to inherent limitations as they reflect the exercise of judgments by management about which expenses and income are excluded or included in determining these non-GAAP financial measures. You should review the Company's and Zanite's audited financial statements, which will be included in the definitive proxy statement relating to the Transaction. Reconciliations of historical non-GAAP measures to their most directly comparable GAAP counterparts are included in the Appendix to this presentation. Additionally, to the extent that forward-looking non-GAAP financial measures are provided, they are presented on a non-GAAP basis without reconciliations of such forward-looking non-GAAP measures due to the inherent difficulty in forecasting and quantifying certain amounts that are necessary for such reconciliations.

Private Placement

The securities to which this presentation relates have not been registered under the Securities Act, or the securities laws of any other jurisdiction. This presentation relates to securities that Zanite intends to offer in reliance on exemptions from the registration requirements of the Securities Act and other applicable laws. These exemptions apply to offers and sales of securities that do not involve a public offering. The securities have not been approved or recommended by any federal, state or foreign securities authorities, nor have any of these authorities passed upon the merits of this offering or determined that this presentation is accurate or complete. Any representation to the contrary is a criminal offense.

2020 Preliminary Financial Information

Eve's audited consolidated financial statements for the twelve months ended December 31, 2020 are not yet available. This presentation includes certain preliminary unaudited financial information for the twelve months ended December 31, 2020 that is based solely on Eve's management's estimates reflecting currently available preliminary information, and remains subject to Eve's consideration of subsequent events. Eve's independent registered public accounting firm has not audited, reviewed, and does not express an opinion with respect to, this financial information. Eve's final consolidated financial results as of and for the twelve months ended December 31, 2020 may materially differ from the estimates and the interim balances set forth in this presentation. Such estimates constitute forward-looking statements and are subject to risks and uncertainties, including those described under "Forward-Looking Statements."

Participation in Solicitation

Eve and Zanite and their respective directors and executive officers, under SEC rules, may be deemed to be participants in the solicitation of proxies of Zanite's shareholders in connection with the proposed Transaction. Investors and security holders may obtain more detailed information regarding the names and interests in the proposed Transaction of Zanite's directors and officers in Zanite's filings with the SEC, including Zanite's annual report on Form 10-K/A, which was originally filed with the SEC on June 14, 2021. To the extent that holdings of Zanite's securities have changed from the amounts reported in Zanite's registration statement on Form S-1, such changes have been or will be reflected on Statements of Change in Ownership on Form 4 filed with the SEC. Information regarding the persons who may, under SEC rules, be deemed participants in the solicitation of proxies to Zanite's shareholders in connection with the proposed Transaction is set forth in the proxy statement for the proposed Transaction, a preliminary version of which has been filed by Zanite with the SEC.

Trademarks

This presentation includes logos or other words or devices that may be registered trademarks of their respective owners. Solely for convenience, some of the trademarks, service marks, trade names and copyrights referred to in this presentation may be listed without the TM, SM, ® or ® symbols, but Zanite and Eve will assert, to the fullest extent under applicable law, the rights of the applicable owners, if any, to these trademarks, service marks, trade names and copyrights. This presentation and its contents are not endorsed, sponsored or affiliated with any trademark owner.

Additional Information About the Transaction and Where to Find It

Zanite intends to submit the Transaction to its security holders for their consideration. The Company has filed a preliminary proxy statement with the SEC and intends to file a proxy statement with the SEC, which will include a preliminary proxy statement and a definitive proxy statement, to be distributed to Zanite's securityholders in connection with Zanite's solicitation for proxies for the vote by Zanite's shareholders in connection with the Transaction and other matters as described in the definitive proxy statement. After the definitive proxy statement on Form DEF14A has been filed, Zanite will mail the definitive proxy statement and other relevant documents to its securityholders as of the record date established for voting on the Transaction. Investors and security holders of Zanite and Eve are urged to read the proxy statement and other relevant documents that have been or will be filed with the SEC carefully and in their entirety when they become available because they will contain important information about the proposed Transaction. Investors and security holders will be able to obtain free copies of the proxy statement and other documents containing important information about Zanite and Eve through the website maintained by the SEC at www.sec.gov. Copies of the documents filed with the SEC by Zanite can be obtained free of charge by directing a written request to Zanite at 25101 Chagrin Boulevard, Suite 350, Cleveland, Ohio 44122. Inquiries regarding this presentation may be directed to Steven H. Rosen, Co-Chief Executive Officer, at 25101 Chagrin Boulevard, Suite 350, Cleveland, Ohio 44122 or by calling (216) 292-0200.

INVESTMENT IN ANY SECURITIES DESCRIBED HEREIN HAS NOT BEEN APPROVED OR DISAPPROVED BY THE SEC OR ANY OTHER REGULATORY AUTHORITY NOR HAS ANY AUTHORITY PASSED UPON OR ENDORSED THE MERITS OF THE OFFERING OR THE ACCURACY OR ADEQUACY OF THE INFORMATION CONTAINED HEREIN. ANY REPRESENTATION TO THE CONTRARY IS A CRIMINAL OFFENSE.



MOBILITY REIMAGINED



1. INTRODUCTION

Transaction Overview

Business Combination Details

Embraer transfer of UAM Business to EVE UAM, LLC ("Eve"), with a commitment to provide certain services to Eve following the transaction

Exchange of Eve units to Zanite for 220M shares of Zanite common stock

Eve will become a wholly owned subsidiary of Zanite, which will change its name to Eve Holding, Inc. at closing and be listed on the NYSE under the symbol "EVEX"

Expected to close in Q2 2022

7 person board (4 independent)

Embraer governance:

- Ordinary 1:1 voting rights
- Consent right for major corporate changes ⁽¹⁾

Valuation

Anticipated pro forma enterprise value of \$2.4B

Implied valuation multiples:

- 1.3x 2028E revenue
- 8.6x 2028E EBITDA

Provides investors with an attractive entry point based on non-binding pipeline and peer group multiples

Strategic PIPE Investors



Capital Structure

Expected to be funded by \$237M cash in trust (assuming no redemptions) and net proceeds from a \$347M PIPE resulting in estimated pro forma net cash of \$549M ⁽²⁾

PIPE consists of:

- \$175M from Embraer
- \$25M from Zanite Sponsor
- \$147M from other investors

Anticipated pro forma ownership: ⁽³⁾

- 76.0% Embraer / Eve rollover ⁽⁴⁾
- 11.8% PIPE investors
- 7.8% Zanite public shareholders
- 2.4% Strategic partner warrants
- 2.0% Zanite founder shares ⁽⁵⁾

Note: Transaction terms are subject to change. Amounts included herein are subject to rounding.

(1) Major corporate changes include a sale, dissolution, relocation, name change, change in the size of the board or any action that would materially adversely affect any approval right to which Embraer is entitled. Embraer's consent right is retained so long as Embraer's ownership remains at or above 35%.

(2) Comprised of \$237M cash in trust (excluding any redemptions by Zanite public shareholders), \$347M in PIPE proceeds and \$5M of estimated Company net cash at Closing, minus \$41M in estimated transaction expenses (after rounding). Eve's funding expectations are subject to change based on a variety of factors, including shareholder redemptions and greater than expected losses.

(3) Based on Eve's 294.0M fully-diluted pro forma shares outstanding under the treasury stock method including: (i) 3.4M initial equity incentive shares granted to Eve employees and board members at closing; and (ii) 7.2M shares issuable upon the exercise of strategic partner penny warrants granted and vested at closing and subject to lock-ups of two to five years; and excluding: (i) 11.5M shares issuable upon the exercise of strategic partner penny warrants subject to milestone-based vesting; (ii) 17.0M shares issuable upon the exercise of strategic partner warrants with a \$13.97 weighted average exercise price granted and vested at closing; (iii) 14.3M shares issuable upon the exercise of Zanite private placement warrants with an \$11.50 exercise price vested at closing and subject to a three year lockup; (iv) 11.5M shares issuable upon the exercise of Zanite public warrants with an \$11.50 exercise price vested at closing; and (v) any redemptions by Zanite public shareholders.

(4) Embraer / Eve rollover line excludes Embraer's committed \$175M investment in the PIPE, which is included in the PIPE investors ownership line. Embraer is expected to have 80.8% pro forma ownership including its PIPE investment.

(5) Zanite founder shares line excludes Zanite Sponsor's committed \$25M investment in the PIPE, which is included in the PIPE investors ownership line. Zanite Sponsor is expected to have 2.8% pro forma ownership including its PIPE investment.

Strategic Backing from an Aviation Leader

Carve-Out Rationale

Enhance Eve's agility, focus and independent decision-making

Provide Eve with the flexibility to pursue new business models and partnerships

Access new pools of capital

Support for Eve

Contribution of all UAM-related employees, assets and IP

Contractual commitment to provide support including: ⁽¹⁾

- Royalty free license to Embraer background IP
- Type certification support
- Use of global infrastructure
- Access to 5,000 skilled employees

Long-term partnership:

- Rolling 100% of equity in Eve
- \$175M investment in the PIPE
- Majority ownership post-close
- Two board seats ⁽²⁾
- Three year lockup on rollover shares ⁽³⁾

Note: Transaction terms are subject to change.

⁽¹⁾ Master Services Agreement to be entered into between Eve and Embraer provides Eve with the option to source engineering, certification manufacturing and other services from Embraer at specified cost-based pricing.

⁽²⁾ Embraer may nominate five board members but three must be independent.

⁽³⁾ Excludes shares acquired by Embraer in the PIPE.



Zanite - SPAC Founded by a Premier Aviation Team

Background

Founders include the principals of Directional Aviation Capital, which built and operates one of the world's largest groups of private aviation companies:

- \$2.4B in annual revenue
- 175+ aircraft
- 2,750+ employees

Directors and advisors have current and former roles with leading Fortune 500 companies

Zanite team provides Eve with the benefits of a synergistic network of businesses and relationships

Support for Eve

Selected Eve after a thorough search

Key aspects of Eve investment thesis:

- ✓ Simplified vehicle design
- ✓ Scalable fleet operations model
- ✓ Proven path to production
- ✓ Global support and distribution

Conducted extensive due diligence

Long-term partnership:

- \$25M investment in the PIPE
- Up to 200 Eve vehicles ordered by Halo, an affiliate of Zanite's sponsor ⁽¹⁾
- One board seat
- Three year lockup on sponsor shares ⁽²⁾

Zanite Leadership Team



Kenn Ricci – Co-CEO and Board Member
Principal, Directional Aviation Capital



Steve Rosen – Co-CEO and Board Member
Co-CEO, Resilience Capital Partners



Mike Rossi – CFO
Principal, Directional Aviation Capital



John Veihmeyer – Board Member
*Former Chairman of KPMG International
Board member of Ford*



Larry Flynn – Board Member
Former President of Gulfstream Aerospace



Pat Shanahan – Board Member
Former Acting Secretary of Defense; Boeing SVP



Ron Sugar – Senior Advisor
*Former CEO of Northrop Grumman
Board member of Amgen, Apple, Chevron and Uber*

Selected Businesses Owned by Directional Aviation Capital

FLEXJET

SENTIENTJET

nextant aerospace

SIMCOM
AVIATION TRAINING

HALO

PRIVATEFLY

REVA

SCF
STONEBRIAR
COMMERCIAL FINANCE

Corporate Wings

(1) Includes purchase option.

(2) Excludes shares acquired by Zanite Sponsor in the PIPE.

Investment Highlights

Attractive Business Fundamentals

Addressing a Massive Global TAM

Pure play focus on a \$0.76T revenue opportunity 2025E – 2040E ⁽¹⁾

Scalable and Sustainable Solution

Most practical eVTOL design, capital efficient fleet operations model and carbon neutrality

Highly Experienced Team

Senior leadership team and board with proven aviation credentials

Significant Execution Advantages

Strategic Support from Embraer

Aviation leader with 30+ aircraft models certified and produced over 25 years

Powerful Partner Network

MOUs and LOIs with dozens of leading partners across the UAM ecosystem ⁽²⁾

Significant Revenue Visibility

Order pipeline of \$5.5B for 1,825 vehicles to 19 launch customers ⁽³⁾

(1) Total addressable market ("TAM") estimate as per "Market for Urban Air Mobility" from KPMG dated June 2021 (includes passenger travel; excludes cargo, defense and emergency services).

(2) Partnerships with Eve or one of its affiliates are non-binding. The number of memoranda of understanding ("MOUs") and LOIs signed by Eve is current as of 3/18/22.

(3) Eve pipeline is based on launch orders (including purchase options) and capacity deals that are non-binding and subject to material change. Capacity deals are converted from annual hourly commitments to vehicles assuming 1,000 hours per vehicle per year. Eve pipeline is current as of 3/18/22.



MOBILITY REIMAGINED



2. HIGHLY SCALABLE UAM SOLUTION

Highly Scalable UAM Solution

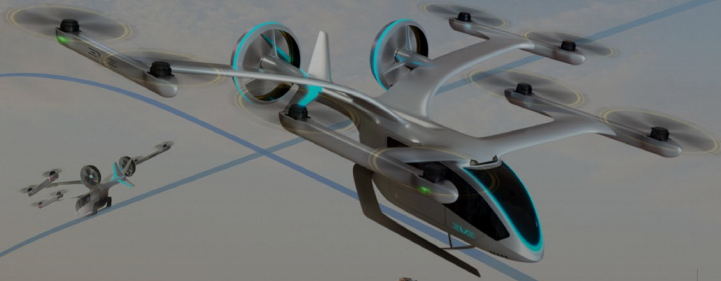

EVTOL DESIGN AND PRODUCTION

Practical design choice drives lowest operational cost and simplest certification path



SERVICE AND SUPPORT

Leveraging Embraer global footprint to enable a sizable and profitable revenue stream



FLEET OPERATIONS

Capital efficient strategy of aligning with operators and scaling partner-by-partner



URBAN AIR TRAFFIC MANAGEMENT

Applying the knowledge from designing Brazil's ATC system to enable safe eVTOL flights

Vehicle Design Optimized for Urban Mobility



Flexible Seating Capacity

4 passengers at entry into service
Up to 6 in autonomous mode ⁽¹⁾

High Utilization Rate

Designed for **thousands** of flight cycles per year with industry-leading reliability

Lift + Cruise Design

Most practical design choice for efficiency and certifiability

Community Friendly

Approximately **90%** lower noise footprint compared to equivalent helicopters ⁽⁴⁾

Tailored for Urban Mobility

100 km (60 mile) range at EIS
Addresses **99%** of UAM missions in cities and metropolitan areas ⁽²⁾

Leading Cost Efficiency

Over **6x** lower cost-per-seat than helicopters and best-in-class for eVTOLs ⁽³⁾

Note: Expected vehicle performance metrics are based on preliminary models, simulations and proof of concepts ("PoCs"). Actual performance characteristics are subject to validation and change.

(1) Eve expects autonomous operations to commence around 2030.

(2) EIS = entry into service. Eve's estimate of serving 99% of UAM missions in cities and metropolitan areas is based on a study of 1,500 markets worldwide conducted by Eve and Massachusetts Institute of Technology.

(3) Helicopter costs are based on an analysis from Conklin & de Decker. Eve vehicle costs are based on Eve analysis.

(4) Data is based on simulations performed by Eve and publicly available noise profile data for a Bell 430 helicopter.

Most Practical Design Choice for UAM Missions

Lift + Cruise



- + Simple design
- + High reliability
- + Straightforward to certify
- + Quiet in cruise mode
- + Low battery drain
- + Simple maintenance



Tilt Rotor



- + High speed
- + Long range
- Complex design
- Lower reliability
- Challenging to certify

Vectored Fan



- + Efficient cruising
- + Long range
- Energy intensive hover
- Take-off noise level
- High battery drain

Multi-Rotor



- + Efficient takeoff and landing
- + Simplest to certify
- Less efficient cruising
- Slower speeds
- Very short range
- High battery drain

Blend of Proven Technology and New Innovations

Patented eight counter-rotating rotor configuration, provides ample redundancy

Blade position control for minimum drag during cruise

Highest certification standards for safety-critical software

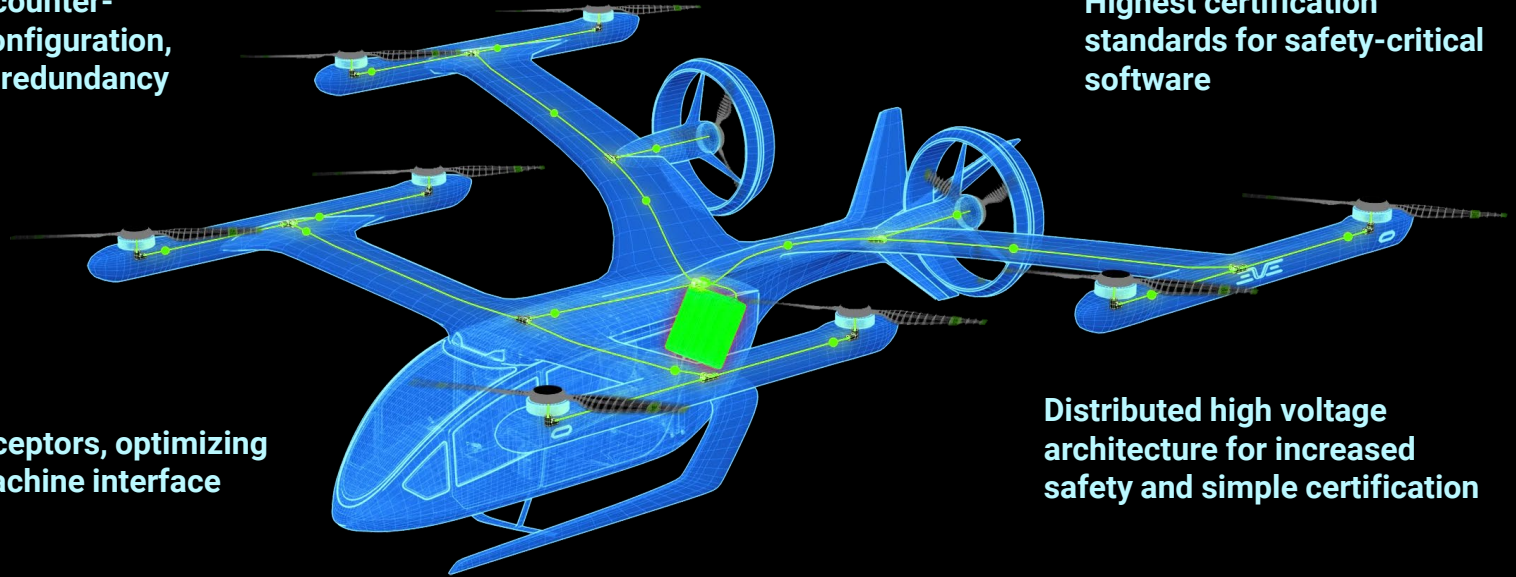

Bespoke inceptors, optimizing the man-machine interface

Distributed high voltage architecture for increased safety and simple certification

5th generation closed loop fly-by-wire system

Universal cabin with enhanced accessibility features

Timeline to Achieve Entry Into Service

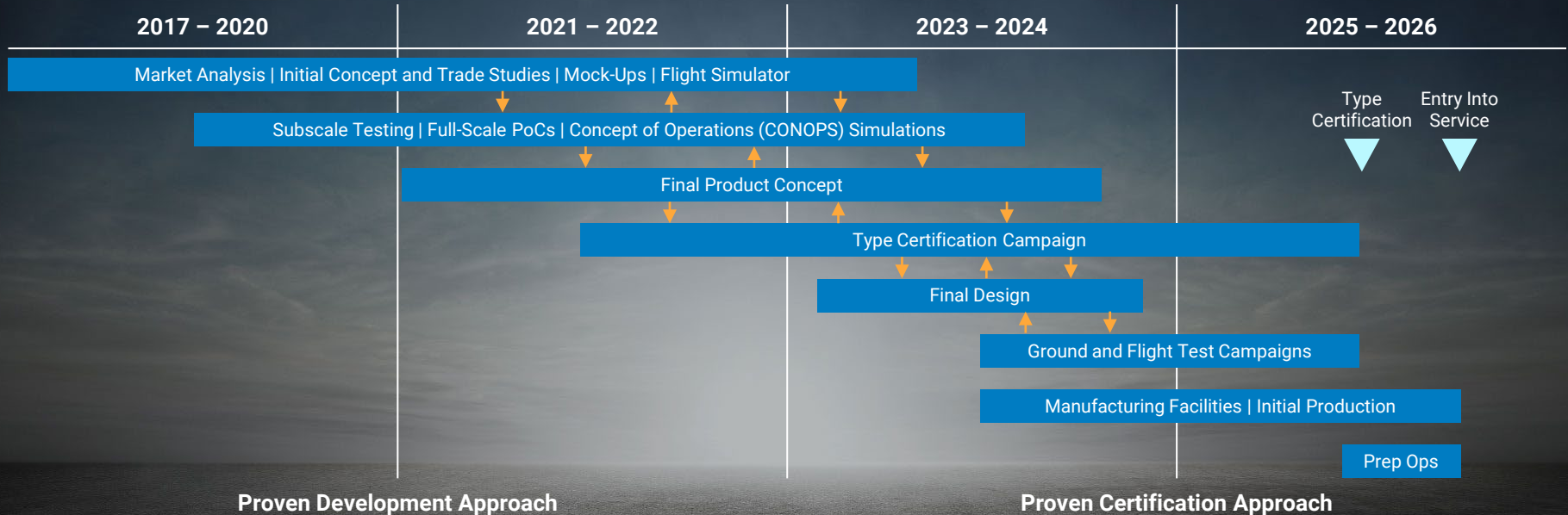

- Employing the development model evolved by Embraer over 50+ years, enabling consistent completion of programs on-time, on-spec and under budget
- Balanced and deterministic approach incorporates agile, model-based engineering techniques and iterative use of testing environments and PoCs

- Engaging with ANAC in Brazil as the primary certification authority, with a bilateral agreement with the FAA and follow-on certification from EASA
- Approach leverages Embraer’s success with triple type certifications and long-standing relationships with all global regulatory authorities

Scalable Approach to Global Fleet Operations



Eve plans to build out its fleet operations business in collaboration with partners

Eve will not own aircraft, but will instead establish joint operations and grow partner-by-partner

Benefits to Eve:

- ✓ Maximize capital efficiency
- ✓ Accelerate time-to-market
- ✓ Leverage partner capabilities
- ✓ Share revenues and risks

Eve has signed MOUs and LOIs with 19 operating partners: ⁽¹⁾

- 6 fixed wing operators
- 9 helicopter operators
- 4 ride sharing platform providers

Experienced Leadership Team

Senior Management Team



Jerry DeMuro
Co-CEO



Andre Stein
Co-CEO



Eduardo Couto
CFO



Luiz Valentini
CTO



Flávia Pavie
General Counsel and CCO



Alice Altissimo
Head of Program
Management



Luiz Mauad
Head of Services
and Fleet Operations



Flavia Ciaccia
Head of User
Experience



David Rottblatt
Head of Business
Development



Luana Campos
Head of Employee
Journey

Post-Closing Directors Agreed To Date



Luis Carlos Affonso
SVP, Engineering, Technology
and Strategy, Embraer



Michael Amalfitano
CEO, Embraer
Executive Aircraft



Kenn Ricci
Co-CEO, Zanite Acquisition
Corp. and Principal,
Directional Aviation Capital



Marion Clifton Blakey
Former CEO, Rolls-Royce
North America; Former FAA
Administrator



Paul Eremenko
CEO, Universal Hydrogen;
Former CTO, Airbus



Sergio Pedreiro
Former COO, Revlon; Former
CEO, Estre Ambiental



José Manuel Entrecanales
Chairman and CEO, Acciona



EVE

MOBILITY REIMAGINED

3. STRATEGIC SUPPORT FROM EMBRAER

Heritage of Aviation Leadership

For 50+ years, Embraer has established itself as a leader in a number of aviation categories

UAM is the next major growth opportunity for Embraer to capitalize on via Eve

- #1 share of commercial jets with up to 150 seats
- 200 commercial airline customers in 75 countries
- #1 selling executive jet in the industry
- 940 executive jet customers in 65 countries
- 4,350 aircraft currently in operation



Superior Certification Track Record

Eve plans to leverage Embraer's regulatory experience and relationships to accelerate type certification

Years From Start of Development to Certification

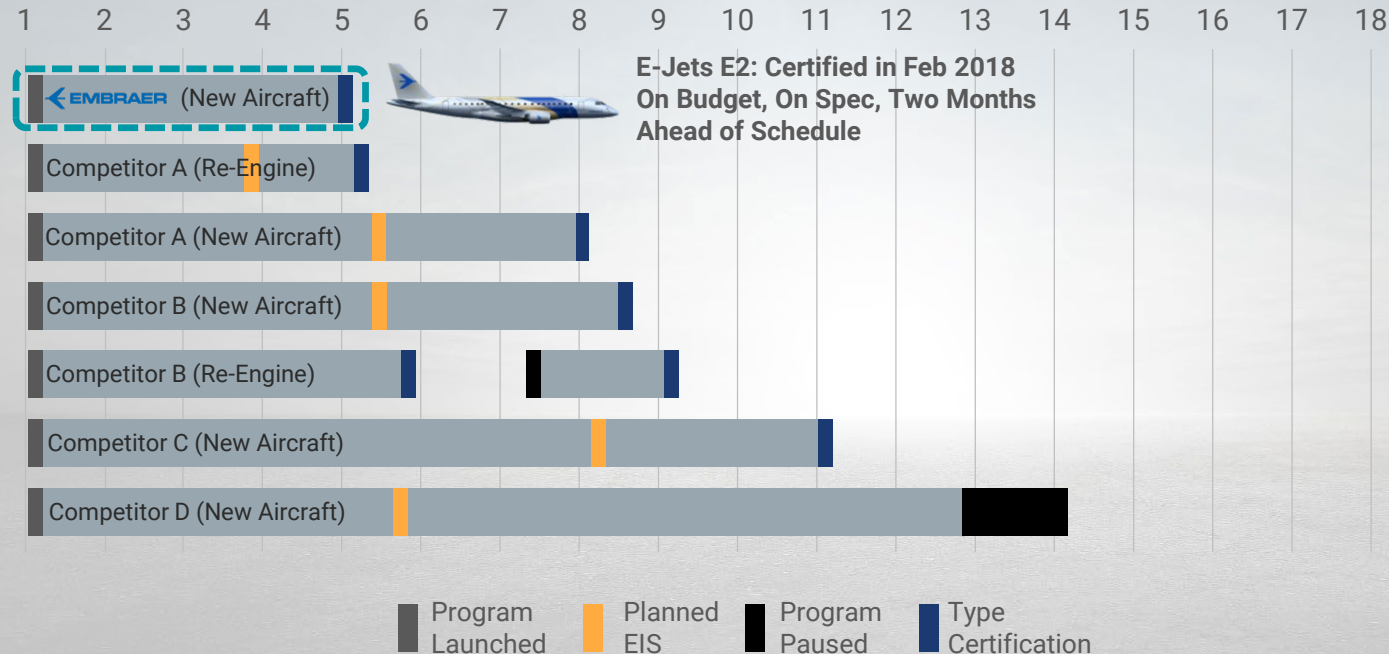

30+

New models certified
by Embraer over
the last 25 years



**Experience with
Simultaneous
Certifications**

Embraer has consistently
achieved triple type certification
in Brazil, US and Europe for both
commercial and executive jets

Leveraging World-Class Capabilities of Embraer



Significant cost advantage over startups

- ✓ Service agreements with Embraer will provide Eve with vast resources at favorable rates ⁽¹⁾
- ✓ Contribution of UAM IP and a royalty-free license to Embraer's background IP
- ✓ 5,000 Embraer employees will be available to support Eve on a first priority basis ⁽²⁾
- ✓ Includes 1,600 named engineers with world-class design and aeronautical expertise
- ✓ As-a-service model allows Eve to efficiently flex-up and flex-down resource utilization
- ✓ Eve benefits from Embraer's infrastructure and cost-competitive production capabilities



(1) Master Services Agreement to be entered into between Eve and Embraer provides Eve with the option to source engineering, certification manufacturing and other services from Embraer at specified cost-based pricing
(2) Pursuant to Master Services Agreement entered into between Eve and Embraer.

Global Presence with Local Support

Eve is uniquely suited to support its customers by leveraging Embraer's worldwide infrastructure

80 Countries

10 Embraer
Service Centers

66 Third-Party
Service Centers

24 Warehouses

77 Flight
Simulators

5 Pilot Training
Centers



MOBILITY REIMAGINED

An aerial photograph of a coastal city, likely Miami, showing a mix of high-rise apartment buildings and residential neighborhoods. A futuristic, white flying car with two large propellers is in the foreground, flying over a canal. Another smaller flying car is visible in the distance over the ocean. The sky is blue with some clouds, and the sun is low on the horizon, creating a warm glow.

4. POWERFUL PARTNER NETWORK

Building a Global Partner Ecosystem

Helicopter Operators



Fixed Wing Operators



Vertiports



Renewable Energy



Ride Sharing Platforms



Lessors

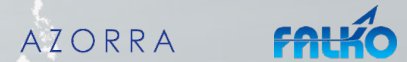

Technology



Defense



Financing / Development

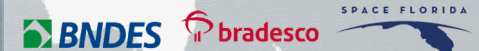

Airline Partnership



SkyWest operates a fleet of over 450 aircraft connecting passengers to over 230 destinations throughout North America

Operates regional jets (including Embraer jets) for major US carriers

Partnership with Eve: ⁽¹⁾

- 100 eVTOL launch order
- Potential collaboration for aircraft operations
- Strategic investor in the PIPE



Hubs

Chicago | Denver | Detroit | Houston | Los Angeles

Minneapolis/St. Paul | Phoenix | Portland | Salt Lake City

San Francisco | Seattle

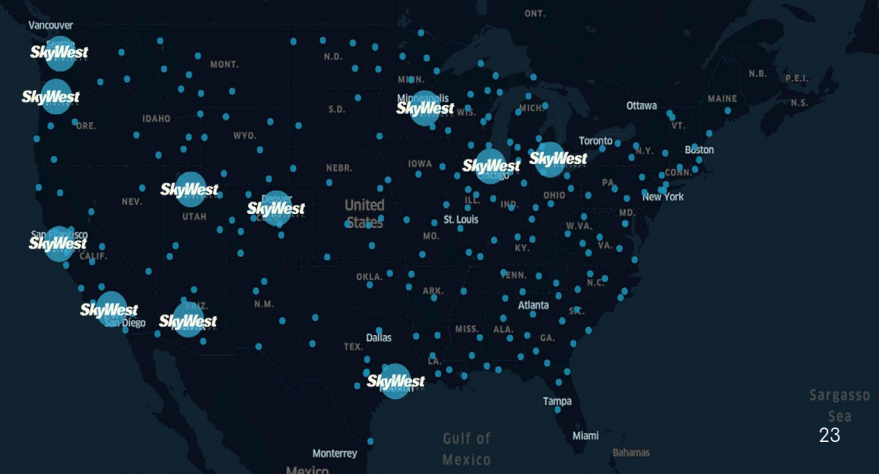

(1) Launch order and potential collaboration for aircraft operations are non-binding and subject to material change.

Airline Partnership

Republic Airways operates a fleet of more than 200 aircraft serving 100 cities in the US, Canada, the Caribbean and Central America

Operates regional jets (including Embraer jets) for major US carriers

Partnership with Eve: ⁽¹⁾

- Up to 200 eVTOL launch order ⁽²⁾
- Potential collaboration for aircraft operations
- Strategic investor in the PIPE



Hubs

Charlotte | Chicago | Columbus | Houston
Indianapolis | Kansas City | Louisville | Miami
Newark | New York City | Philadelphia
Pittsburgh | Washington DC



(1) Launch order and potential collaboration for aircraft operations are non-binding and subject to material change.
(2) Includes purchase option.

Selected Helicopter Partnerships

Avantto operates aircraft and helicopters, completing more than 6,000 flights per year with over 450 active customers

Partnership with Eve: ⁽¹⁾

- 100 eVTOL launch order
- Potential collaboration for aircraft operations



Halo provides bespoke helicopter and private urban air mobility travel services in the US and UK

Formed through the combination of Halo Aviation and Associated Aircraft Group in May 2021

Partnership with Eve: ⁽¹⁾ ⁽²⁾

- Up to 200 eVTOL launch order ⁽³⁾
- Potential collaboration for aircraft operations
- Vehicles expected to operate in the US and UK

⁽¹⁾ Launch order and potential collaboration for aircraft operations are non-binding and subject to material change.

⁽²⁾ Halo Aviation is an affiliate of Directional Aviation and Zanite Sponsor.

⁽³⁾ Includes purchase option.

Lessor Partnerships

Falko is a specialist aircraft operating leasing, asset management and aircraft services company focused on the regional aircraft sector. It is currently the world's third largest lessor of regional aircraft by value and aircraft numbers with offices in the UK, Ireland and Singapore.

Partnership with Eve ⁽¹⁾

- 200 eVTOL launch order
- Potential collaboration to develop a network of eVTOL operators
- Strategic investor in the PIPE



(1) Launch order is non-binding and subject to material change.

(2) Includes purchase option.



Azorra is a full-service aircraft leasing platform with a clean balance sheet focusing on regional, crossover and small narrowbody aircraft. Azorra's team has a 25+ year track record and has owned and managed more than 275 aircraft in over 70 countries

Partnership with Eve ⁽¹⁾

- Up to 200 eVTOL launch order ⁽²⁾
- Potential collaboration to develop a network of eVTOL operators
- Strategic investor in the PIPE

Defense Partnership

BAE Systems is a global leader in defense technology spanning air, maritime, land and cyber domains

Significant scale with 89,600 employees in 40 countries and annual revenue of \$26B

Partnership with Eve and Embraer ⁽¹⁾

- Global defense collaboration
- Strategic investor in the PIPE

Leading Defense Franchises

Electronic Warfare | Cyber | Combat Air
Combat Ships | Combat Vehicles | Cyber
Undersea Warfare | Multi-Domain Capabilities

(1) Potential collaboration for defense applications is non-binding and subject to material change.



BAE SYSTEMS



MOBILITY REIMAGINED

A futuristic flying car, resembling a white and grey quadcopter with a sleek, aerodynamic body and a cockpit, is shown in flight. It has the 'EVE' logo on its side. The background features a cityscape with tall skyscrapers, a harbor filled with many small boats, and a large bridge spanning across the water. The scene is set during sunset or sunrise, with a warm, golden glow.

5. COMPELLING INVESTMENT OPPORTUNITY

Addressing a \$0.76 Trillion Global TAM

Eve's 2030E revenue forecast implies only 15% market penetration

UAM Passenger Total Addressable Market ⁽¹⁾

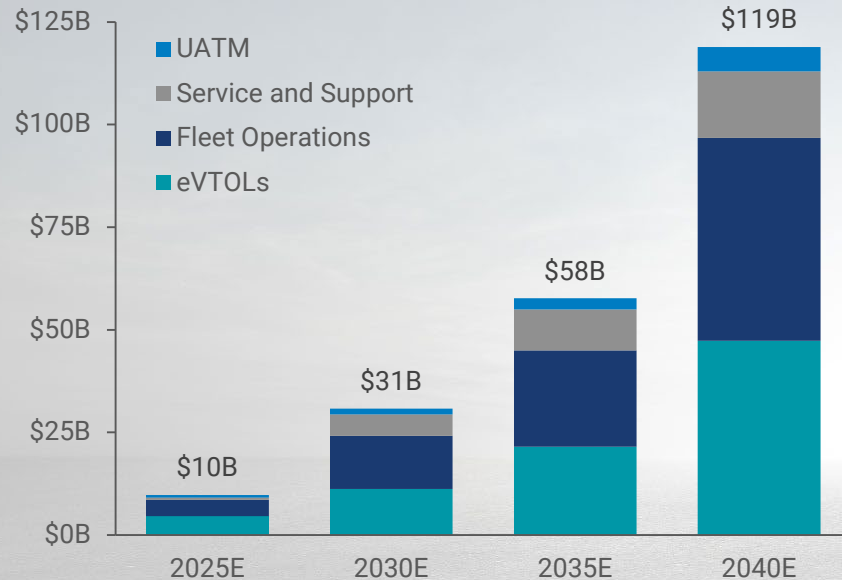

Embraer Market Share Examples ⁽²⁾



#1 Market Share | 29%
Commercial Jets <150 seats



#1 Market Share | 28%
Light Jets

Note: TAM of \$0.76T refers to the aggregate revenue opportunity from 2025E – 2040E.

(1) TAM estimate as per "Market for Urban Air Mobility" from KPMG dated June 2021 (includes passenger travel; excludes cargo, defense and emergency services).

(2) Market share statistics from Embraer management and public filings.

Accelerating Revenue Visibility

Eve Non-Binding Order Pipeline of \$5.5B ⁽¹⁾

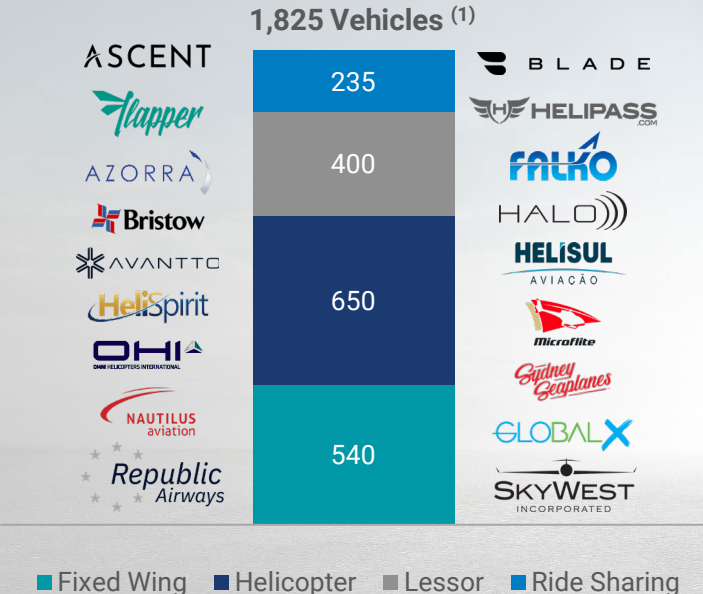

Eve Vehicle Delivery Forecast

(Estimated Number of Vehicles Delivered Per Year)

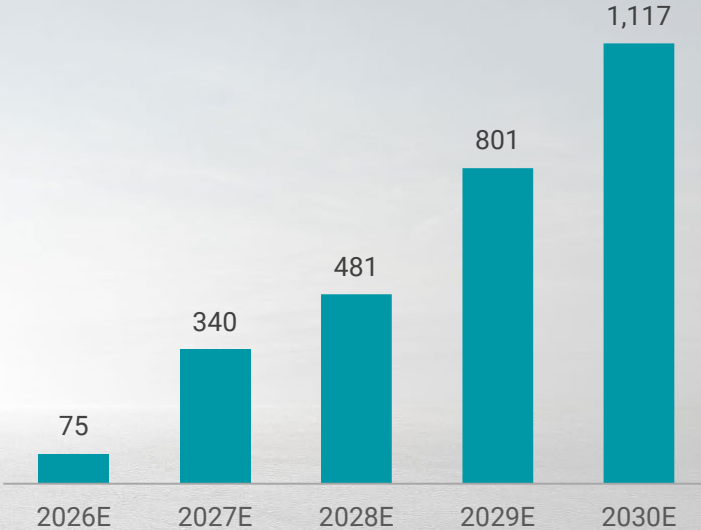

(1) Eve pipeline is based on launch orders (including purchase options) and capacity deals that are non-binding and subject to material change. Capacity deals are converted from annual hourly commitments to vehicles assuming 1,000 hours per vehicle per year. Eve pipeline is current as of 3/18/22.

Revenue Growth Plan

\$ in millions

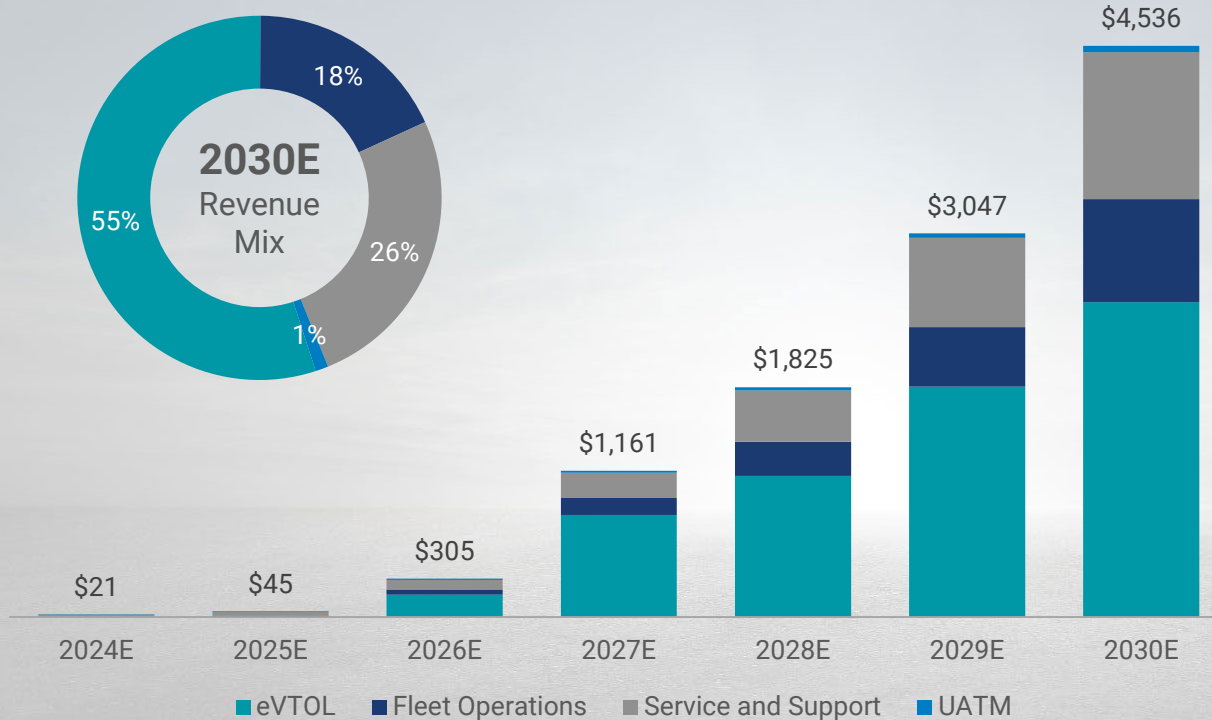

- eVTOL revenue is expected to begin scaling in 2026E with planned entry into service
- Fleet operations and service and support revenues are expected to reach 44% of total revenue by 2030E
- UATM is expected to be a strategic and high margin revenue source

Financial Forecast

\$ in millions

	2024E	2025E	2026E	2027E	2028E	2029E	2030E
eVTOL Deliveries	--	--	75	340	481	801	1,117
Revenue	\$21	\$45	\$305	\$1,161	\$1,825	\$3,047	\$4,536
Y/Y Growth	73%	121%	570%	281%	57%	67%	49%
Non-GAAP Gross Profit ⁽¹⁾	(\$1)	\$2	\$13	\$179	\$422	\$750	\$1,171
Non-GAAP Gross Margin	N.M.	5%	4%	15%	23%	25%	26%
EBITDA ⁽²⁾	(\$109)	(\$88)	(\$60)	\$67	\$278	\$518	\$840
EBITDA Margin	N.M.	N.M.	N.M.	6%	15%	17%	19%
Capex	(\$158)	(\$209)	(\$258)	(\$273)	(\$245)	(\$293)	(\$337)
Free Cash Flow ⁽³⁾	(\$269)	(\$299)	(\$316)	(\$211)	\$28	\$203	\$475

- Forecasted gross and EBITDA margins reflect Embraer's experience with past aircraft programs
- Eve expects to be EBITDA positive for the full year of 2027E
- Excluding manufacturing capex, Eve requires approximately \$540M to fund its plan ⁽⁴⁾
- Manufacturing capex is expected to be funded through working capital commitments ⁽⁵⁾

Note: Estimates are from Eve management. Eve financials are prepared in accordance with US GAAP accounting principles.

(1) Non-GAAP gross profit is defined as gross profit excluding depreciation and amortization and stock-based compensation expense included in cost of goods sold.

(2) EBITDA is a non-GAAP measure and defined as net income (loss) before depreciation and amortization, income taxes, interest income / (expense) and stock-based compensation.

(3) Free cash flow is a non-GAAP measure and defined as EBITDA minus income taxes (excluding Tax Receivable Agreement payments), changes in net working capital and capital expenditures.

(4) Eve's funding expectations are subject to change based upon a variety of factors, including shareholder redemptions and higher than expected losses.

(5) Eve's working capital commitment is based upon a non-binding LOI from the Brazilian Development Bank (BNDES).

Transaction Overview

\$ in millions, except per share data

Sources

Embraer Rollover	\$2,200
Cash in Trust	\$237
PIPE Equity	\$347
Total Sources	\$2,784

Uses

Embraer Rollover	\$2,200
Cash to the Balance Sheet	\$544
Estimated Fees and Expenses	\$41
Total Uses	\$2,784

Pro Forma Valuation

Share Price	\$10.00
Pro Forma Shares Outstanding ⁽¹⁾	294.0
Equity Value	\$2,940
Less: Net Cash ⁽²⁾	\$549
Enterprise Value	\$2,392

Pro Forma Ownership ⁽¹⁾



Note: Transaction terms are subject to change. Amounts included herein are subject to rounding.





(1) Fully-diluted pro forma shares outstanding under the treasury stock method including: (i) 3.4M initial equity incentive shares granted to Eve employees and board members at closing; and (ii) 7.2M shares issuable upon the exercise of strategic partner penny warrants granted and vested at closing and subject to lock-ups of two to five years; and excluding: (i) 11.5M shares issuable upon the exercise of strategic partner penny warrants subject to milestone-based vesting; (ii) 17.0M shares issuable upon the exercise of strategic partner warrants with a \$13.97 weighted average exercise price granted and vested at closing; (iii) 14.3M shares issuable upon the exercise of Zanite private placement warrants with an \$11.50 exercise price vested at closing and subject to a three year lockup; (iv) 11.5M shares issuable upon the exercise of Zanite public warrants with an \$11.50 exercise price vested at closing; and (v) any redemptions by Zanite public shareholders.

(2) Comprised of \$237M cash in trust (excluding any redemptions by Zanite public shareholders), \$347M in PIPE proceeds and \$5M of estimated Company net cash at Closing, minus \$41M in estimated transaction expenses (after rounding).

(3) Embraer / Eve rollover excludes Embraer's committed \$175M investment in the PIPE, which is included in the PIPE investors ownership line. Embraer is expected to have 80.8% pro forma ownership including its PIPE investment.

(4) Zanite founder shares excludes Zanite Sponsor's committed \$25M investment in the PIPE, which is included in the PIPE investors ownership line. Zanite Sponsor is expected to have 2.8% pro forma ownership including its PIPE investment.

Eve Execution Advantages vs. UAM Peers

					
Enterprise Value ⁽¹⁾	\$2.4B	\$0.6B	\$2.2B	\$0.4B	\$1.5B
Value of Pipeline ^{(2) (3)}	\$5.5B	\$1.5B	Not Applicable	\$1.7B	\$5.4B
Enterprise Value / Pipeline Value	0.44x	0.37x	Not Applicable	0.26x	0.27x
Number of Vehicles in Pipeline ^{(2) (3)}	1,825	300	Not Applicable	370	1,350
Number of Customers in Pipeline ^{(2) (3)}	19	1	Not Applicable	2	8
Year Founded ⁽⁴⁾	2017	2018	2009	2015	2016
eVTOL Design Choice	Lift + Cruise	Tilt Rotor	Tilt Rotor	Ducted Fan	Tilt Rotor
Fleet Operations Approach ⁽⁵⁾	Partner-by-Partner	City-by-City	City-by-City	City-by-City	Partner-by-Partner
Service & Support ⁽⁵⁾	●	◐	◑	◑	○
UATM ⁽⁵⁾	●	◐	◑	◑	◑
Proven Aviation Backer	Embraer	None	None	None	None
Strategic Investors ⁽³⁾	Acciona Azorra, BAE, Bradesco, Falko, Republic, Rolls-Royce, SkyWest, Space Florida, Thales	United Airlines, Stellantis	Toyota, Intel Capital, Uber, JetBlue	Tencent, Ferrovial, Palantir	Microsoft, Rolls-Royce, American Airlines, Honeywell, Avolon

(1) Enterprise value for Eve is based on the proposed transaction value. All other enterprise values are based on public information and trading prices from Capital IQ as of 3/18/22.

(2) Eve pipeline is based on launch orders (including purchase options) and capacity deals that are non-binding and subject to material change. Capacity deals are converted from annual hourly commitments to vehicles assuming 1,000 hours per vehicle per year.

(3) Pipeline and partner data for UAM peers is based on information publicly disclosed in the companies' press releases and SPAC investor presentations as of 3/18/22.

(4) Eve founding date reflects the year that Embraer started its internal UAM program. Eve was established as a separate legal entity in 2020.

(5) Assessment based on "Market for Urban Air Mobility" from KPMG dated June 2021.

Positioned to be the Premier Player in UAM



- ✓ Transformational \$0.76T Market Opportunity
- ✓ Efficient and Certifiable Vehicle Design
- ✓ Proven Certification / Production Track-Record
- ✓ Worldwide Sales and Support Network
- ✓ \$5.5B Pipeline Driven by Best-in-Class Partners
- ✓ Experienced Executive Team and Board
- ✓ High-Growth, Capital Efficient Business Model
- ✓ Attractive Valuation Entry Point



EVE

MOBILITY REIMAGINED

APPENDIX

Strong Consumer Demand for Urban Air Mobility

14K+

Survey responses from 30+ countries

200+

Interviews with potential passengers and community members

50+

Interviews with pilots, operators and air traffic controller

89% of Consumers Would Frequently Utilize UAM Transportation

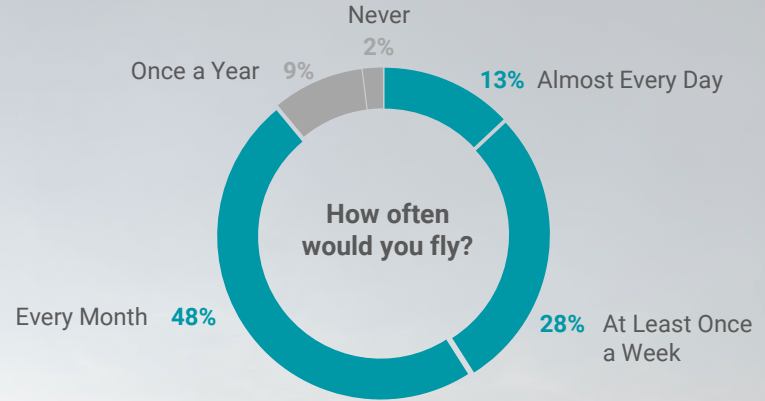

83% of Consumers Would Pay a Premium for UAM Transportation

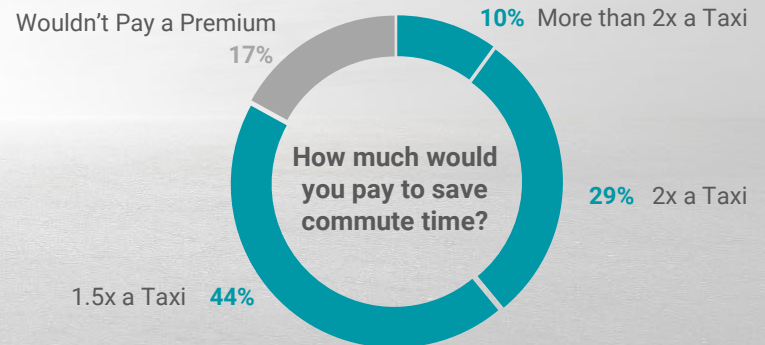

Consumer Prices Comparable to Ground Options

Passenger Price for a Typical 30 km (20 mile) Trip

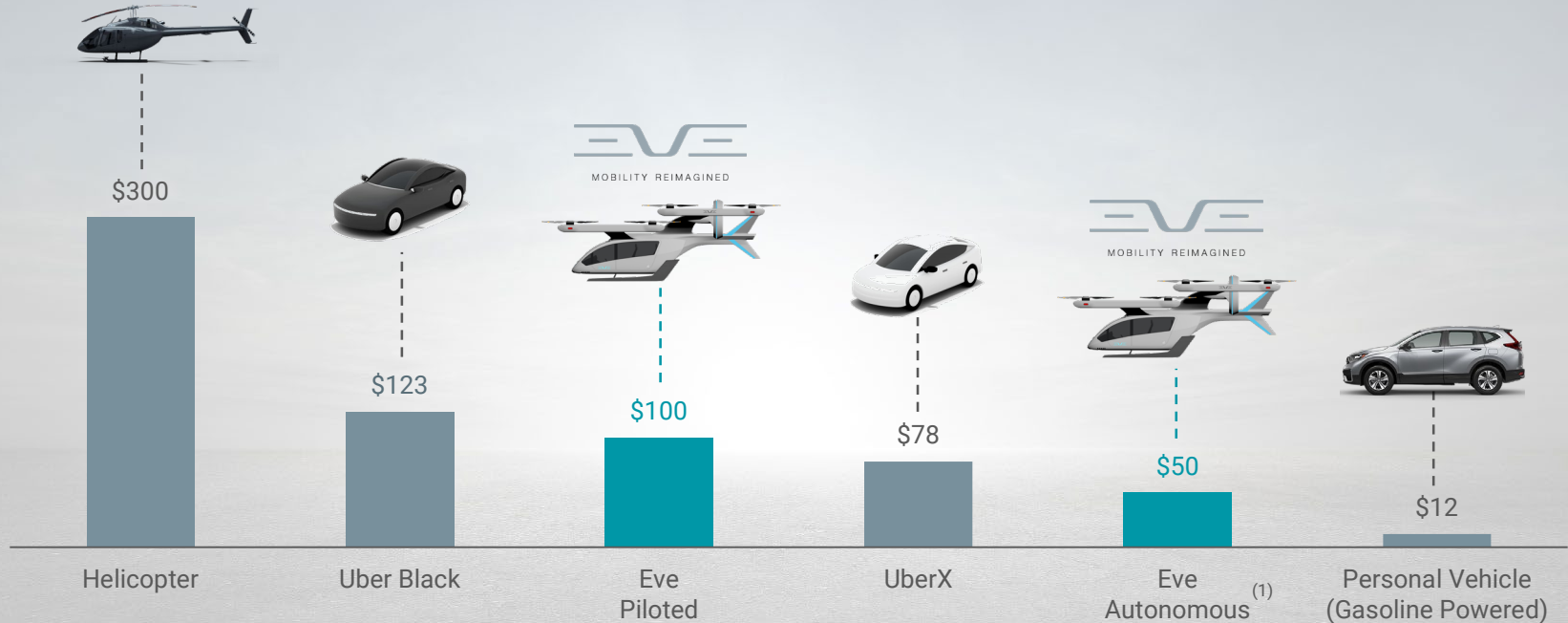

Source: UAM forecasted price per seat mile is based on analysis from Massachusetts Institute of Technology and Eve.
(1) Eve expects autonomous operations to commence around 2030.

Network Scales Rapidly and Saves Passengers Time

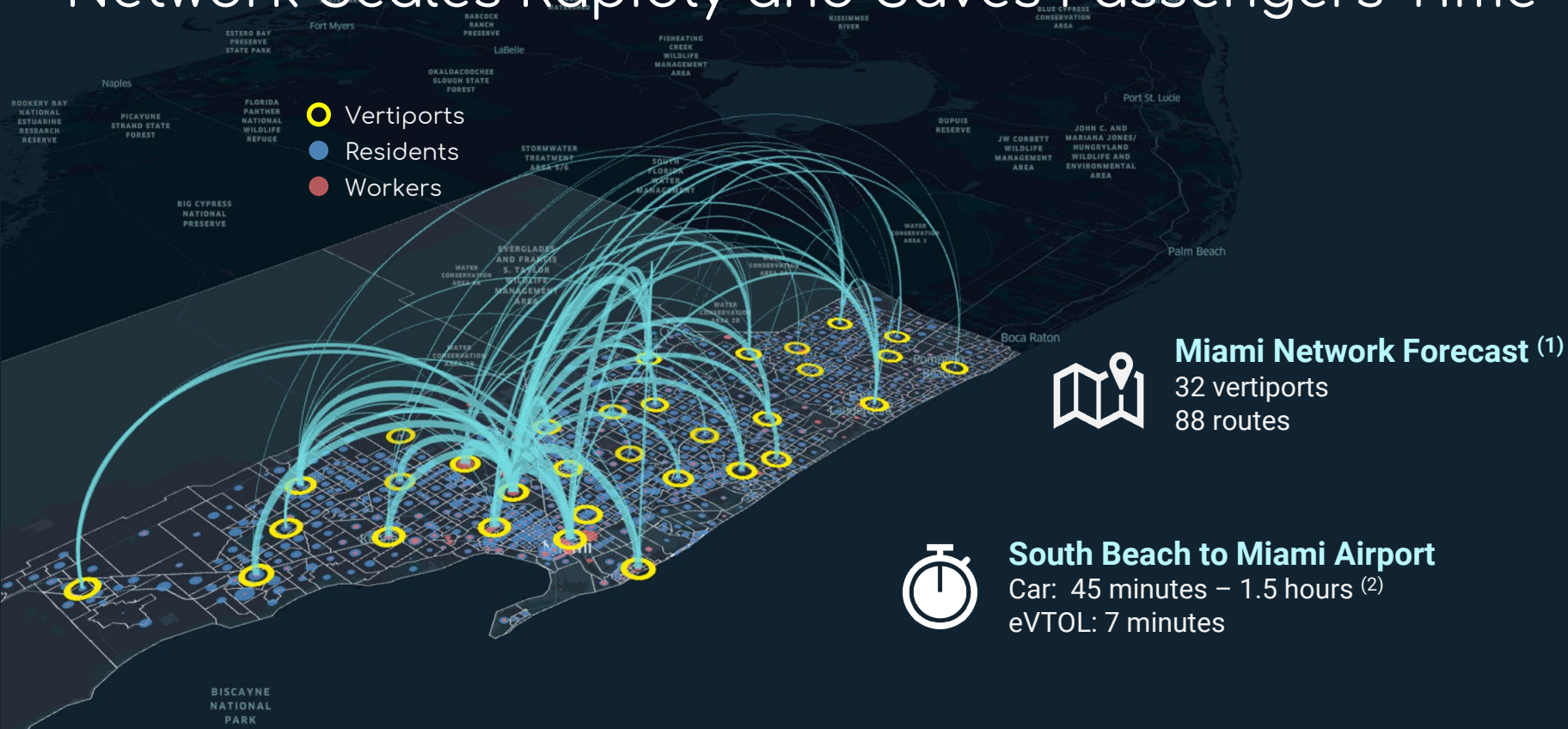

(1) Data based on UAM network design tool developed by Eve in collaboration with Massachusetts Institute of Technology.
(2) Commute time under moderate-heavy traffic conditions.

Environmentally Friendly Aviation



100%
electric
vehicle



ZERO
local
carbon
emissions



FULL
LIFE-CYCLE
design
approach



UP to 80%
CO₂ emission
reduction
versus cars ⁽¹⁾



CARBON
NEUTRALITY
achievable with
minimum cost

(1) Data for internal combustion engine vehicles from the European Environmental Agency.

Designed to Deliver the Lowest Operational Cost

Estimated Direct Operational Cost Per Seat for a Typical 30 km (20 mile) Trip

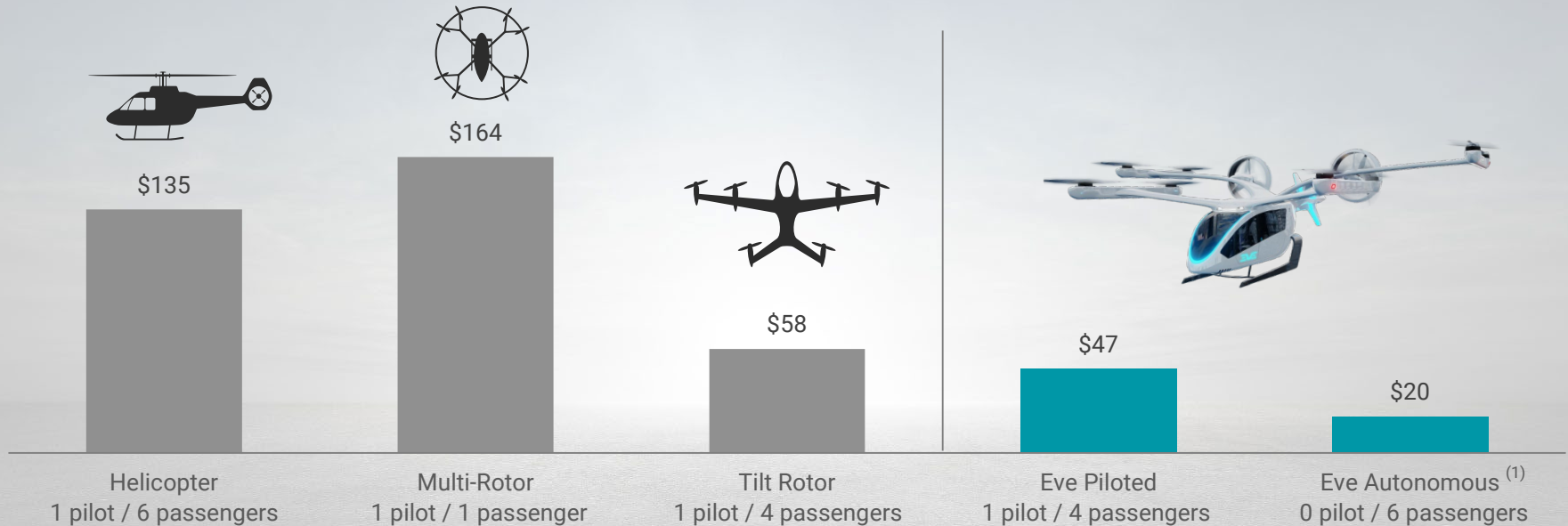

Source: Estimated helicopter costs are based on an analysis from Conklin & de Decker. All other costs are based on Eve analysis.

(1) Eve expects autonomous operations to commence around 2030.

Cabin Experience Driven by Human-Centered Design

The image shows the interior of an aircraft cabin. Two seats are visible, facing forward. The seats are light grey with blue lower sections and green seatbelts. The cabin walls are light grey, and the floor is dark blue. Large windows are on either side, showing a view of the sky. The text 'EVE' is visible on the backrests of the seats and on the wall panel above them. The overall design is modern and minimalist.

Co-Created

Eve engaged with future passengers to create the ideal cabin experience

Inclusive

Welcoming to all passengers based on lifestyle, age, culture and accessibility needs

Optimized

Efficient design for optimal cabin space, vehicle weight and passenger comfort

Comprehensive Service and Support

Eve plans to provide eVTOL services leveraging Embraer's top-ranked product support capabilities ⁽¹⁾



Material Services



Maintenance Services



Technical Services



Flight Operations and Training



Ground Handling



Data Services

- ✓ Vital element to scale UAM services
- ✓ Key selling point for eVTOL customers
- ✓ Provides a predictable revenue stream
- ✓ Leverages Embraer's global network
- ✓ Agnostic approach (Eve and third parties)

(1) Embraer was ranked #1 in the 2021 Corporate Aircraft Product Support Survey based on data compiled by Conklin & de Decker and reported by Pro Pilot.

Urban Air Traffic Management

Vital Need for Urban Air Traffic Management (UATM)

Conventional voice-based air traffic control (ATC) cannot scale to handle the projected volume of flights in low altitude urban airspace

Eve Advantage

UATM software platform is being developed in partnership with Embraer – developer of the ATC system in Brazil

Market Validation

Eve is validating its UATM approach through CONOPS collaborations with stakeholders in Brazil, London and Australia ⁽¹⁾

Strategic Portfolio Element

Enables Eve to engage with customers, communities and regulatory agencies at a strategic level, while creating a high margin and recurring revenue source



Conventional Aircraft



eVTOLs



Drones

(1) A concept of operations (CONOPS) is a document that describes a proposed system concept and how that concept would be operated in an intended environment. Eve completed a CONOPS in Australia in December 2020, and its other CONOPS are ongoing.

Fostering Development of UAM Operations Globally

Eve is developing and testing a Concept of Operations (CONOPS) in selected cities to help define the airspace design, procedures and infrastructure for safely integrating eVTOL operations into low altitude urban airspace

CONOPS leadership allows Eve to engage early with regulatory agencies and other key stakeholders to optimize Eve's vehicle design and foster UAM market development by defining the rules and regulations that do not exist today

Initial CONOPS locations and collaborators:

Rio de Janeiro, Brazil

Skyports | Universal
Rio Galeão | ABAG | Flapper
EDP | Beacon | Helisul
Atech | ANAC | DECEA

London, UK

Atech | Vertical
Volocopter | Skyports
London City Airport
NATS | Heathrow

Melbourne, Australia

Airservices

Miami, Florida

Skyports | L3Harris
Community Air Mobility
Initiative

Risk Factors

The risks presented below are certain of the general risks related to EVE UAM LLC, including the urban air mobility business it will own (collectively, "Eve"), Zanite Acquisition Corp. ("Zanite") and the proposed business combination between Eve and Zanite (the "Business Combination"), and such list is not exhaustive. The list below has been prepared solely for purposes of the private placement transaction, and solely for potential private placement investors, and not for any other purpose. You should carefully consider these risks and uncertainties, and should carry out your own diligence and consult with your own financial and legal advisors concerning the risks and suitability of an investment in this offering before making an investment decision. Risks relating to the business of Eve will be disclosed in future documents filed or furnished by Eve and Zanite with the U.S. Securities and Exchange Commission ("SEC"), including the documents filed or furnished in connection with the Business Combination. The risks presented in such filings will be consistent with those that would be required for a public company in its SEC filings, including with respect to the business and securities of Eve and Zanite and the Business Combination, and may differ significantly from, and be more extensive than, those presented below.

Risks Related to Eve's Business, Industry, Financial Condition, and Results of Operations

- The market for Urban Air Mobility (UAM) has not been established with precision, is still emerging and may not achieve the growth potential Eve expects, or may grow more slowly than expected.
- There may be reluctance by consumers to adopt this new form of mobility, or unwillingness to pay Eve's projected prices.
- There may be rejection of eVTOL operation in certain localities due to a perceived risk of safety or burden on local communities from eVTOL operations.
- Eve may be unable to obtain relevant regulatory approvals for the commercialization of its aircraft, including Type Certification, Production Certification, Operating Certification, approvals for permitting new infrastructure or access existing infrastructure or otherwise.
- Eve will be subject to rapidly changing and increasingly stringent laws, regulations, industry standards, and other obligations relating to privacy, data protection, and data security. The restrictions and costs imposed by these requirements, or its actual or perceived failure to comply with them, could harm its business.
- If current airspace regulations are not modified to increase air traffic capacity, or new regulations are introduced that restrict air traffic, Eve's business could be adversely affected.
- Eve may not be able to launch its eVTOL and related services on the timeline projected and may not be able to produce aircraft in the volumes and on the timeline projected.
- Eve's competitors may commercialize their technology before Eve does, either in general or in specific markets.
- Eve's customers' perception of Eve and Eve's reputation may be impacted by the broader industry, and customers may not differentiate Eve's services from its competitors.
- Eve's aircraft may require maintenance at frequencies or at costs which are unexpected and could adversely impact its business and operations.
- Eve's prospects and operations may be adversely affected by changes in consumer preferences, discretionary spending and other economic conditions that affect demand for UAM services, including changes resulting from the COVID-19 pandemic.
- Neither Eve nor Embraer has yet manufactured or delivered to customers any eVTOL aircraft, which makes evaluating Eve's business and future prospects difficult and increases the risk of investment.
- Eve's eVTOL aircraft may not perform at the level it expects, and may have potential defects, such as higher than expected noise profile, lower payload than initially estimated, shorter range, higher unit cost, higher cost of operation, perceived discomfort during transition phase and/or shorter useful lives than Eve anticipates.
- Crashes, accidents or incidents of eVTOL aircraft or involving UATM solutions, lithium batteries involving Eve or its competitors could have a material adverse effect on Eve's business, financial condition, and results of operations.
- Unsatisfactory safety performance of Eve's aircraft could have a material adverse effect on its business, financial condition, and results of operation.
- There is a shortage of pilots and mechanics which could increase the costs of operating Eve's eVTOL and reduce the ability to deploy Eve's eVTOL service at scale.
- Eve currently relies and will continue to rely on Embraer and third-party partners to provide and store the services, products, parts and components required to manufacture our aircraft, transport the aircraft to final customer and to supply critical services, components and systems, which exposes us to a number of risks and uncertainties outside its control.
- Eve's ability to operate its business effectively depends in large part on certain administrative and other support functions provided to it by Embraer pursuant to the Services Agreements. Following the expiration or termination of the Services Agreements, Eve's ability to operate its business effectively may suffer if it is unable to cost-effectively establish its own administrative and other support functions in order to operate as a stand-alone company.
- Eve may have received better terms from unaffiliated third parties than the terms it has received in the services agreements with Embraer S.A.
- Eve will rely on supplier and service partners to transport the aircraft to the final customer and to supply other critical services and systems necessary for Eve's operations, including to provide aerial ridesharing services and to make the necessary changes to, and operate, vertiports using Eve's aircrafts, which exposes Eve to risks and uncertainties outside its control. Eve's agreements with such supplier and service partners are all non-binding. If Eve does not enter into definitive agreements with such supplier and service partners, or the conditions to any such agreements (if any) are not met, or if such agreements (if any) are cancelled, modified or delayed, or if such third party customers and commercial partners do not otherwise make the services sufficiently convenient to drive customer adoption, Eve's prospects, results of operations, liquidity and cash flow will be harmed.
- Changes in government regulation imposing additional requirements and restrictions on Eve's operations could increase its operating costs and result in service delays and disruptions.
- The UAM Business is subject to stringent U.S. export and import control laws and regulations. Unfavorable changes in these laws and regulations or U.S. government licensing policies, Eve's failure to secure timely U.S. government authorizations under these laws and regulations, or Eve's failure to comply with these laws and regulations could have a material adverse effect on Eve's business, financial condition and results of operations.
- The electric vertical take-off and landing (eVTOL) aircraft industry may not continue to develop, eVTOL aircraft may not be adopted by the market or Eve's independent third-party aircraft operators, eVTOL aircraft may not be certified by transportation authorities or eVTOL aircraft may not deliver the expected reduction in operating costs, any of which could adversely affect Eve's prospects, business, financial condition and results of operations.
- Urban Air Traffic Management (UATM) may not be able to provide adequate situational awareness and equitable airspace access to eVTOLs or may not allow industrial scalability.
- The regulatory environment for third-party service and technology providers (which UATM could be labeled as) may not be specific enough to support Eve's UATM solution, or may delay its adoption.
- Eve's UATM solution may underperform if it has a defect or it is not delivered on the projected timeline.
- Eve is an early stage company with a history of losses, and it expects to incur significant losses for the foreseeable future and it may not be able to achieve or maintain profitability.
- Eve may not be able to secure adequate insurance policies, or secure insurance policies at reasonable prices.
- Eve may be unable to manage its future growth effectively, which could make it difficult to execute its business strategy.
- Eve's available capital resources may not be sufficient to meet its requirements for additional capital.
- Eve may in the future invest significant resources in developing new offerings and exploring the application of Eve's proprietary technologies for other uses and those opportunities may never materialize.
- Eve may be unable to make certain advances in technology such as autonomous flying technologies, or such technologies may not mature or be commercially available at the rates projected by Eve, which could adversely affect Eve's business, financial condition and results of operations.

Risk Factors (cont.)

- Eve's operating and financial results forecast relies in large part upon assumptions and analyses that Eve has developed. If these assumptions or analyses prove to be incorrect, Eve's actual operating and financial results may be significantly below its forecasts.
- If relations between Eve and its strategic partners were to deteriorate or terminate, Eve's business could be adversely affected or such third parties could act in a manner adverse to Eve.
- Eve is subject to risks associated with climate change, including the potential increased impacts of severe weather events on its operations and infrastructure.
- Eve's aircraft utilization may be lower than expected and our aircraft may be limited in its performance during certain weather conditions.
- Eve has been, and may in the future be, adversely affected by health epidemics and pandemics, including the ongoing global COVID-19 pandemic, the duration and economic, governmental and social impact of which is difficult to predict, which may significantly harm our business, prospects, financial condition and operating results.
- Eve is or may be subject to risks associated with strategic alliances or acquisitions and may not be able to identify adequate strategic relationship opportunities, or form strategic relationships, in the future.
- UAM Business' historical financial results and combined financial statements may not be representative of Eve's results as a separate company.
- If Eve or Embraer S.A. experience harm to their reputation and brand, Eve's business, financial condition and results of operations could be adversely affected.
- Eve is subject to many hazards and operational risks that could disrupt its business, including interruptions or disruptions in service at our facilities, which could have a material adverse effect on its business, financial condition and results of operations.
- Brazilian political and economic conditions have a direct impact on Eve's business, and political instability in Brazil could have a material adverse effect on Eve's business, financial condition and results of operations and the price of its common stock.
- Any further downgrading of Brazil's credit rating could adversely affect the market price of shares Eve's common stock.
- Any decrease in Brazilian government-sponsored customer financing, or increases in government-sponsored financing that benefits Eve's competitors, may decrease the competitiveness of its aircraft.
- Inflation and government efforts to combat inflation may contribute significantly to economic uncertainty in Brazil and to heightened volatility in the Brazilian securities markets and, consequently, may adversely affect the Eve's business, financial condition and results of operations.
- Developments and the perception of risk in Brazil and other countries, especially in other emerging markets, may adversely affect Eve's common stock.
- Political instability, including as a result of ongoing corruption investigations, may adversely affect Eve's business and results of operations.
- Infrastructure and workforce deficiency in Brazil may impact economic growth and have a material adverse effect on Eve.
- Exchange rate volatility may adversely affect Eve.

Risks Related to Eve's People

- The loss of one or more of Eve's executive officers, key employees, or an inability to attract and retain highly skilled employees could adversely affect Eve's business.
- Eve's management team has limited experience managing a public company.
- Claims for indemnification by Eve's directors and officers may reduce Eve's available funds to satisfy successful third-party claims against Eve and may reduce the amount of money available to Eve.
- Eve's business may be adversely affected by union activities.

Risks Related to Eve's Intellectual Property and Cybersecurity

- Data loss, errors, or corruption due to failures in Eve's systems may damage Eve's reputation and relationships with existing customers, which could have a negative impact on its business, operations, and financial performance.
- Eve's business is subject to online security risks, and if Eve is unable to safeguard the security and privacy of confidential data, it may face significant liabilities and its reputation and business will be harmed.
- If Eve is unable to obtain, maintain and enforce intellectual property protection for Eve's technology and products or if the scope of its intellectual property protection is not sufficiently broad, others may be able to develop and commercialize technology and products substantially similar to Eve's, and Eve's ability to successfully commercialize its technology and products may be adversely affected.
- Third parties may initiate legal proceedings alleging that Eve is infringing or otherwise violating their intellectual property rights, the outcome of which would be uncertain and could have a material adverse effect on Eve's business, financial condition, and results of operations.
- Any restrictions on Eve's use of, or ability to license, data, or Eve's failure to license data and integrate third-party technologies, could have a material adverse effect on Eve's business, operations, and financial performance.
- If Eve's trademarks and trade names are not adequately protected, Eve may not be able to build name recognition in its markets of interest and its business may be adversely affected.
- If Eve is unable to protect the confidentiality of Eve's trade secrets, know-how, and other proprietary information, the value of its technology and products could be adversely affected.

Risks Related to Eve's Tax, Financial and Accounting Matters

- As a public reporting company, Eve will be subject to rules and regulations established by the SEC and the NYSE regarding Eve's internal control over financial reporting. Eve may not complete needed improvements to its internal control over financial reporting in a timely manner, or these internal controls may not be determined to be effective, which may adversely affect investor confidence in Eve's company and, as a result, the value of Eve's stock and your investment.
- The failure to successfully implement and maintain accounting systems could materially adversely impact Eve's business, results of operations, and financial condition.
- Following the Business Combination, Eve's failure to timely and effectively implement controls and procedures required by Section 404(a) of the Sarbanes-Oxley Act that will be applicable to it after the Business Combination is consummated could have a material adverse effect on its business.
- Changes in tax laws may adversely affect Eve, and the Internal Revenue Service or a court may disagree with tax positions taken by Eve.

Risks Related to Zanite and the Business Combination

- There are material risks to unaffiliated investors presented by taking Eve public through a business combination rather than through an underwritten offering.
- Directors of Zanite have potential conflicts of interest in recommending that its stockholders vote in favor of approval of the Business Combination.
- Zanite's initial stockholders, officers and directors may agree to vote in favor of the Business Combination, regardless of how its public stockholders vote.
- Zanite's sponsors, directors, officers, advisors, and their affiliates may enter into certain transactions, including purchasing shares or warrants from public stockholders, which may influence a vote on the Business Combination and reduce the public "float" of its securities.

Risk Factors (cont.)

- Zanite's warrants and the additional private placement warrants it may be obligated to issue to its sponsor are accounted for as derivative liabilities and the changes in value of Zanite's derivative liabilities could have a material effect on Zanite's financial results.
- Zanite has identified a material weakness in its internal control over financial reporting. This material weakness could continue to adversely affect Zanite's ability to report its results of operations and financial condition accurately and in a timely manner.
- Zanite and, following the Business Combination, Eve, may face litigation and other risks as a result of any material weaknesses that may be identified in Zanite's internal control over financial reporting.
- The combined company may invest or spend the proceeds of the Business Combination and private placement in ways with which the investors may not agree or in ways which may not yield a return.
- Each of Zanite and Eve have incurred and will incur substantial costs in connection with the Business Combination, private placement and related transactions, such as legal, accounting, consulting, and financial advisory fees, which will be paid out of the proceeds of the Business Combination and the private placement.
- The ability of Zanite's public stockholders to exercise redemption rights with respect to a large number of shares could deplete Zanite's trust account prior to the Business Combination and thereby diminish the amount of working capital of the combined company.
- Subsequent to the consummation of the Business Combination, the combined company may be required to take write-downs or write-offs, restructuring and impairment or other charges that could have a significant negative effect on its financial condition, results of operations and share price, which could cause you to lose some or all of your investment.
- Uncertainty about the effect of the Business Combination may affect Eve's ability to retain key employees and integrate management structures and may materially impact the management, strategy, and results of its operation as a combined company.
- Neither the Zanite board of directors nor any committee thereof obtained a third-party valuation in determining whether or not to pursue the Business Combination.
- Zanite is an emerging growth company subject to reduced disclosure requirements, and there is a risk that availing itself of such reduced disclosure requirements will make its common stock less attractive to investors.
- The consummation of the Business Combination is subject to a number of conditions and if those conditions are not satisfied or waived, the Business Combination agreement may be terminated in accordance with its terms and the Business Combination may not be completed.
- Legal proceedings in connection with the Business Combination, the outcomes of which are uncertain, could delay or prevent the completion of the Business Combination.
- Changes to the proposed structure of the Business Combination may be required as a result of applicable laws or regulations.
- Following the Business Combination, anti-takeover provisions contained in Eve's certificate of incorporation and bylaws, as well as provisions of Delaware law, could impair a takeover attempt.
- Following the Business Combination, Eve's certificate of incorporation and bylaws will provide for an exclusive forum in the Court of Chancery of the State of Delaware for certain disputes between Eve and its stockholders, and that the federal district courts of the United States will be the exclusive forum for the resolution of any complaint asserting a cause of action under the Securities Act of 1933, which could discourage claims or limit stockholders' ability to make a claim against Eve, its directors, officers, other employees or stockholders.
- Eve will incur significant expenses as a result of being a public company, which could materially adversely affect Eve's business, results of operations, and financial condition.
- The only principal asset of the combined company following the Business Combination will be its interest in Eve and

- accordingly, it will depend on distributions from Eve to pay taxes and expenses.
- Zanite and Eve will be subject to business uncertainties and contractual restrictions while the Business Combination is pending, and such uncertainty could have a material adverse effect on Zanite's and Eve's business, financial condition, and results of operations.
- If Zanite is deemed to be an investment company under the Investment Company Act, it may be required to institute burdensome compliance requirements and its activities may be restricted, which may make it difficult to complete the Business Combination.
- Zanite does not have a specified maximum redemption threshold. The absence of such a redemption threshold may make it possible for Zanite to complete its initial business combination with which a substantial majority of its stockholders or warrant holders do not agree.

Risks Related to Eve's Securities Following Consummation of the Business Combination

- If the benefits of the Business Combination do not meet the expectations of investors or securities analysts, the market price of Eve's common stock may decline.
- An active trading market for Eve's shares of common stock may not be available on a consistent basis to provide stockholders with adequate liquidity. The stock price may be volatile, and stockholders could lose a significant part of their investment.
- There can be no assurance that the common stock issued in connection with the Business Combination will be approved for listing on the NYSE following the closing, or that the combined company will be able to comply with the continued listing standards of the NYSE.
- Because Eve has no current plans to pay cash dividends for the foreseeable future, you may not receive any return on investment unless you sell your shares for a price greater than that which you paid for them.
- If, following the Business Combination, securities or industry analysts do not publish or cease publishing research or reports about Eve, its business, or its market, or if they change their recommendations regarding Eve's securities adversely, the price and trading volume of Eve's securities could decline.
- Future sales and issuances of Eve's common stock or rights to purchase Eve's common stock, including pursuant to Eve's equity incentive plans, or other equity securities or securities convertible into Eve's common stock, could result in additional dilution of the percentage ownership of Eve's stockholders and could cause the stock price of Eve's common stock to decline.
- Warrants will become exercisable for the combined company's common stock, which would increase the number of shares eligible for future resale in the public market and result in dilution to the combined company's stockholders.
- Investors in this offering will experience immediate and substantial dilution.
- The combined company may issue shares of preferred stock in the future, which could make it difficult for another company to acquire it or could otherwise adversely affect holders of its common stock.
- Stockholders will experience immediate dilution as a consequence of the issuance of common stock as consideration in the Business Combination. Having a minority share position may reduce the influence that stockholders have on the management of the Company.



MOBILITY REIMAGINED