

## Warranty



To receive after sales service, have the following ready when you contact our branches

1. Name of the product
2. Model number of the product
3. The area of problem
4. Phone number and address at which you can be contacted.

## Warranty Card

PRODUCT	
MODEL	
DATE PURCHASED	
WARRANTY PERIOD	
AGENCY	
AGENCY ADDRESS	

◎ KOCOM Warranties the original purchaser of this product as follows.

- 1) This product is produced under strict quality control and inspection procedures.
- 2) If this product breaks down during proper use as a result of product defect, KOCOM will repair it within one year from date of purchase free of charge.
- 3) The following cases will be subject to charge, even during warranty period:
  - a. Breakdown during transport, or through careless treatment, by consumer.
  - b. Breakdown caused by unauthorized repair, or system modification.
  - c. Breakdown caused by natural disaster or power disorder.

DP-203H-01 | 04. 11

MADE IN KOREA

# KOCOM

# DOORPHONE

DP-203HA/DP-203HD/DP-203D USER(INSTALLATION) MANUAL

## Features

- Gentle electronic chime bell sound.
- Used DC 12V (DP-203D)
- Used DC 6V (4Piece of 1.5V batteries into housing, lasts 10months)-DP-203HD
- Communication range:  $\phi$  0.65mm wire, 300m line
- Can be combined with door opener.

Thank you very much for purchasing KOCOM Doorphone. please read this manual thoroughly to ensure correct usage, before operating

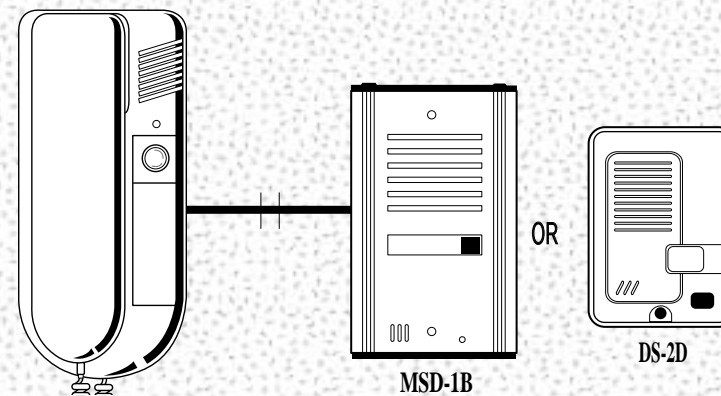

DP-203HA (110V or 127V or 220V)

DP-203HD (DC 6V)

DP-203D (AC/DC 12V)

OR

DS-2D

MSD-1B

KOCOM CO.,LTD.

## Precautions for Operation

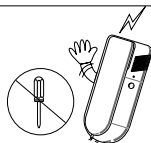

As this device consists of precise electronic components, and high voltage is generated internally, do not attempt to disassemble.



Do not drop Indoor or outdoor station, and avoid strong impact.

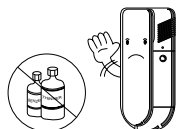

When cleaning, never use wet hands, volatile benzene or paint thinner.



Keep away from humidifier and stove. High temperature and humidity can cause malfunction

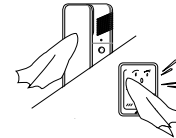

Maintain the product clear by frequently cleaning doorstation with soft cloths

## Name of Each Part

### Indoor Station

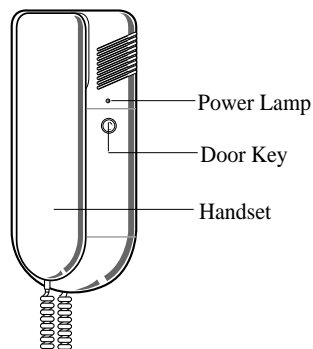

### Out door Station

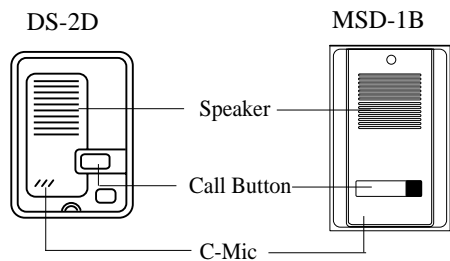

## How to operate (Instruction for operating)

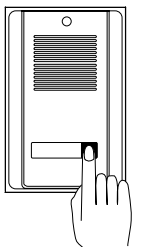

When a visitor pushes the outdoor station bell,

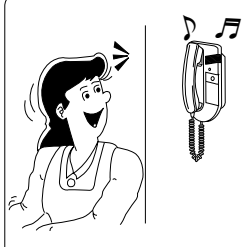

The indoor station is ringing.



Pick up the handset and communicate with a visitor. After end of communication, return the handset where it is locked

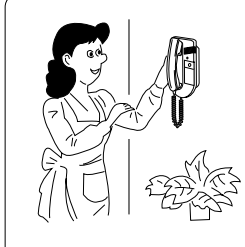

To release the door, press the "Door Key" button

## Wring Diagram

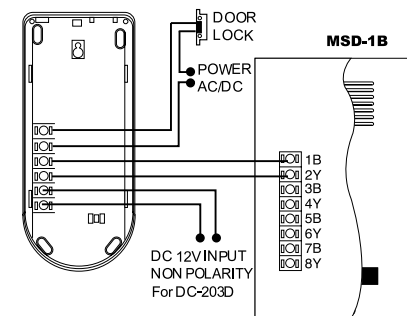
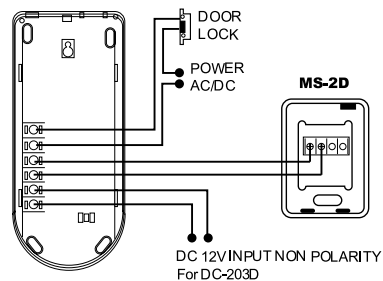

## Installation

### Installation of Indoor station

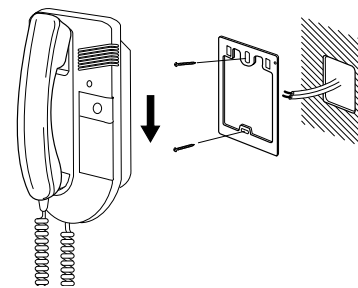

- A- Choose a place on the wall where you want to hang the Indoor station.  
 B- Fasten the wall hanger on the wall.  
 C- Indoor station can be hung on the wall hanger easily now.

### Installation of outdoor station

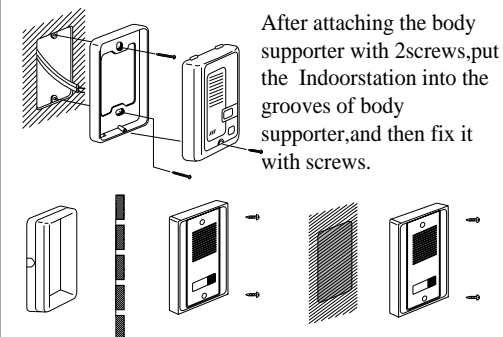

Outdoor station can be attached on a wall or on a door as shown on the drawing.

## Specifications

Description	DP-203HA	DP-203HD	DP-203D
Electric source	AC 120V, AC 220V	DC 6V(LR6-AA 1.5V X 4)	DC 12V ±2V Non Polarity
Consumption	In use 30mA,Signal 150mA	In use 30mA,Signal 150mA	In use 30mA,Signal 150mA
Signal Sound	Electronic chime	Electronic chime	Electronic chime
Wiring	2Wired	2Wired	2Wired
Range	300m(φ 0.65mm)	300m( φ 0.65mm)	300m( φ 0.65mm)

## Component

- Master station for Indoor-use
- Substation for Outdoor-use
- Wall hanger for master station



■ DP-203HA

■ KDP-601A

## [ DP-203HA / KDP-601A ]

- Upto 4 houses connection
- Audio conversation with visitor
- Door open (common gate) function
- Gentle electronic sound
- Easy installation (mount on the wall or desk)

## [ MSD-1B, MSD-2B, MSD-3B, MSD-4B ]

- Aluminum common gate panel
- 1 house (MSD-1B)
- Upto 2 house (MSD-2B)
- Upto 3 house (MSD-3B)
- Upto 4 house (MSD-4B)



MSD-1B

MSD-2B

MSD-3B

MSD-4B

### Specifications

Model no.	DP-203HA	KDP-601A
Power	AC110V or AC220V (± 10%)	
Power consumption	Max. 30mA	
Assurance temperature	0°C ~ +50°C	
Wiring	2wires	
Max. wiring distance	Ø0.65 single cable : 300m, 5C-2V coaxial cable : 500m	
Mount type	Surface mount	
Dimension (mm)	92(W) x 210(H) x 57(D)	
Weight (Approx. kg)	0.5kgs	

• The product may include option or additional functions.



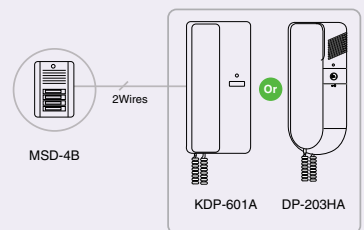
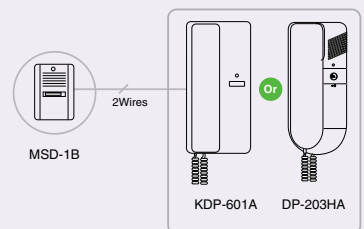

### Diagram

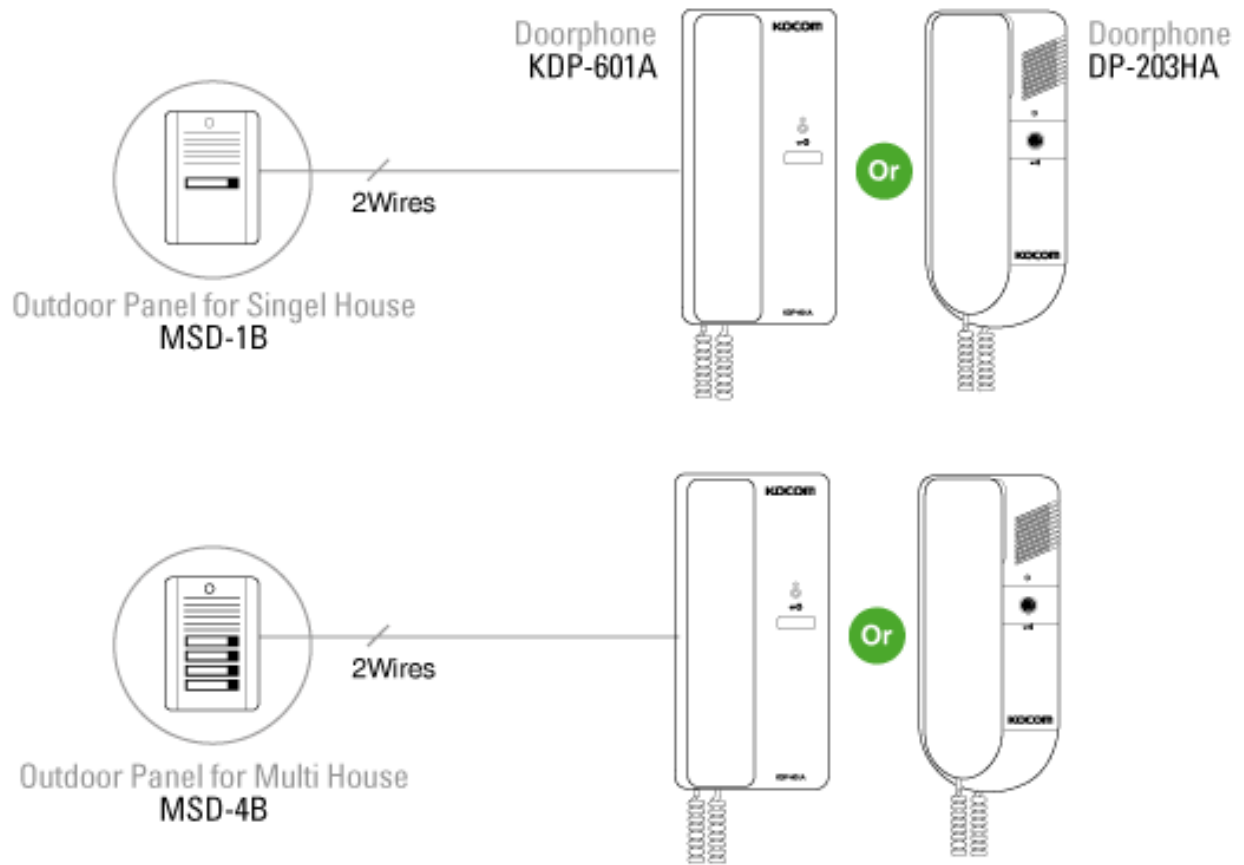









## [ Outdoor Panel Series ]

## ●●● Multi house Series

Model No.	MSD-2B	MSD-3B	MSD-4B
			
Power	Powered from audio handset		
Assurance temperature	-20°C ~ +50°C		
Body material	Aluminum		
Mount type	Flush mount		
Dimension	122(W) x 199(H) x 35(D) (mm)		
Weight (kgs)	0.6kgs		
Audio handset	DP-203HA / DP-203HD / KDP-60A/ KDP-601D / DP-906H		
Connection			

## ●●● Singel house Series

Model No.	MSD-1B	DS-2D	MS-2D(S)	MS-2D(B)	KC-MD10	KC-MD20
						
Power	Powered from audio handset					
Assurance temperature	-20° C ~ +50°C					
Body material	Aluminum	Plastic	Metal			
Mount type	Flush mount	Surface mount				
Dimension	122(W) x 199(H) x 35(D) (mm)	95(W) x 127(H) x 32(D) (mm)			77(W) x 38(H) x 18(D) (mm)	67(W) x 145(H) x 20(D) (mm)
Weight (kgs)	0.6kgs	0.5kgs	0.6kgs		0.3kgs	0.5kgs
Audio handset	DP-203HA / DP-203HD / DP-203HD (DC 12V) / KDP-601A / KDP-601D / DP-906H / KIP-222 / KDP-602A/D					
Connection						

# MSD-1B

## Function

Audio handset Connection : DP-203HA / DP-203HD / DP-203HD / KDP-601A / KDP-601D / DP-906H / KIP-222 / KDP-602A / KDP-602D

Body material : Aluminum

Mount type : Flush mount

122(W) x 199(H) x 35(D) mm

## Specification

Item	Specification
Power	Powered from audio handset
Assurance temperature	-20°C ~ +50°C
Body material	Aluminum
Mount type	Flush mount
Dimension	122(W) x 199(H) x 35(D)mm
Weight (kgs)	0.6kgs
Audio handset Connection	DP-203HA / DP-203HD / DP-203HD / KDP-601A/D / DP-906H / KIP-222 / KDP-602A/D

## MSD-2B/ MSD-3B/ MSD-4B

Function

Audio handset Connection : DP-203HA / DP-203HD / KDP-60A/ KDP-601D / DP-906H

Body material : Aluminum

Mount type : Flush mount

122(W) x 199(H) x 35(D) mm

Item	Specification
Power	Powered from audio handset
Assurance temperature	-20°C ~ +50°C
Body material	Aluminum
Mount type	Flush mount
Dimension	122(W) x 199(H) x 35(D)mm
Weight (kgs)	0.6kgs
Audio handset Connection	DP-203HA / DP-203HD / KDP-60A/ KDP-601D / DP-906H